



USB 3.2 Gen 1 Data Extender Kit with Host Wall Plate



AT-USB-EX350-WPH-KIT

Atlona Manuals
Extenders

Version Information

Version	Release Date	Notes
1	Jan 2026	Initial release

Sales, Marketing, and Customer Support

Main Office

Atlona Incorporated
1234 Lakeshore Dr Ste. 150
Coppell, TX 75019
United States
Office: +1.408.962.0515

Sales and Customer Service Hours
Monday - Friday: 8:00 a.m. - 6:30 p.m. (MST)

<https://atlona.com/>

International

+41 43 508 4321 (EMEA)
+65 6305 7575 (APAC)

Sales and Customer Service Hours
Monday - Friday: 09:00 - 17:00 (UTC +1)

Operating Notes



IMPORTANT: Visit <https://www.atlona.com/product/at-usb-ex350-wph-kit> for the latest firmware updates and User Manual.

Warranty



To view the product warranty, use the following link or QR code:

<https://atlona.com/warranty/>

Safety and Certification



CAUTION: TO REDUCE THE RISK OF ELECTRIC SHOCK DO NOT OPEN ENCLOSURE OR EXPOSE TO RAIN OR MOISTURE. NO USER-SERVICEABLE PARTS INSIDE REFER SERVICING TO QUALIFIED SERVICE PERSONNEL.



The exclamation point within an equilateral triangle is intended to alert the user to the presence of important operating and maintenance instructions in the literature accompanying the product.



The information bubble is intended to alert the user to helpful or optional operational instructions in the literature accompanying the product.

1. Read these instructions.
2. Keep these instructions.
3. Heed all warnings.
4. Follow all instructions.
5. Do not use this product near water.
6. Clean only with a dry cloth.
7. Do not block any ventilation openings. Install in accordance with the manufacturer's instructions.
8. Do not install or place this product near any heat sources such as radiators, heat registers, stoves, or other apparatus (including amplifiers) that produce heat.
9. Do not defeat the safety purpose of a polarized or grounding-type plug. A polarized plug has two blades with one wider than the other. A grounding type plug has two blades and a third grounding prong. The wide blade or the third prong are provided for your safety. If the provided plug does not fit into your outlet, consult an electrician for replacement of the obsolete outlet.
10. Protect the power cord from being walked on or pinched particularly at plugs, convenience receptacles, and the point where they exit from the product.
11. Only use attachments/accessories specified by Atlona.
12. To reduce the risk of electric shock and/or damage to this product, never handle or touch this unit or power cord if your hands are wet or damp. Do not expose this product to rain or moisture.
13. Unplug this product during lightning storms or when unused for long periods of time.
14. Refer all servicing to qualified service personnel. Servicing is required when the product has been damaged in any way, such as power-supply cord or plug is damaged, liquid has been spilled or objects have fallen into the product, the product has been exposed to rain or moisture, does not operate normally, or has been dropped.



FCC Compliance

FCC Compliance and Advisory Statement: This hardware device complies with Part 15 of the FCC rules. Operation is subject to the following two conditions: 1) this device may not cause harmful interference, and 2) this device must accept any interference received including interference that may cause undesired operation. This equipment has been tested and found to comply with the limits for a Class A digital device, pursuant to Part 15 of the FCC Rules. These limits are designed to provide reasonable protection against harmful interference in a commercial installation. This equipment generates, uses, and can radiate radio frequency energy and, if not installed or used in accordance with the instructions, may cause harmful interference to radio communications. However there is no guarantee that interference will not occur in a particular installation. If this equipment does cause harmful interference to radio or television reception, which can be determined by turning the equipment off and on, the user is encouraged to try to correct the interference by one or more of the following measures: 1) reorient or relocate the receiving antenna; 2) increase the separation between the equipment and the receiver; 3) connect the equipment to an outlet on a circuit different from that to which the receiver is connected; 4) consult the dealer or an experienced radio/TV technician for help. Any changes or modifications not expressly approved by the party responsible for compliance could void the user's authority to operate the equipment. Where shielded interface cables have been provided with the product or specified additional components or accessories elsewhere defined to be used with the installation of the product, they must be used in order to ensure compliance with FCC regulations.

Copyright, Trademark, and Registration

© 2026 Atlona Inc. All rights reserved. "Atlona" and the Atlona logo are registered trademarks of Atlona Inc. Pricing, specifications and availability subject to change without notice. Actual products, product images, and online product images may vary from images shown here.

All other trademark(s), copyright(s), and registered technologies mentioned in this document are the properties of their respective owner(s).

Table of Contents

Introduction	6
Features	6
Package Contents	6
Panel Description	7
AT-USB-EX350-HS-WP	7
AT-USB-EX350-DV	8
Installation	9
Connection Instructions	9
Connection Diagram	10
IP Configuration	11
Automatic Private IP Addressing (APIPA) Mode	11
Device Operation	12
LED Indicators	12
RS-232 Control	13
Logging in to the Web Server	14
Login Registration	14
Logging in after Registration	15
System Settings	16
Obtaining System Information	16
Changing the Administrator Password	17
Network Configuration	18
Setting the IP Mode	18
IEEE 802.1x Authentication	20
Setting the Host Name	23
System Time	24
Setting the Time Zone	24
Assigning an NTP Server	25
Setting the System Time	26
USB Management	28
USB Configuration	28
USB Info	29
RS-232 Control	32
RS-232 Control Settings	32
System Maintenance	33
Updating the Firmware	33
Performing a Factory Reset	33
Rebooting the System	34
Downloading Log Files	35
Configuration and Management Interfaces	36
Web Server	36
Login	36
System > System	37
System > Network	38
System > Time	40
USB Management > USB Configuration	41
USB Management > USB Info	42
Control	45
Maintenance > System	47
Maintenance > Log	48
Appendix	49
Host Device Mounting Instructions	49
Updating the Firmware	50
Updating using the Web Server	50
Updating over USB	52
Specifications	53

Introduction

The Atlona **AT-USB-EX350-WPH-KIT** is a data only USB 3.2 extender kit featuring a US one-gang wallplate for the host connection. It supports simultaneous extension of 5 Gbps USB 3.2 Gen 1 data and 480 Mbps USB 2.0 data up to 330 feet (100 meters) using a single, cost-effective Category 6A U/FTP cable.

The USB-EX350-WPH-KIT is ideal for video conferencing or remote instruction applications where high data rate USB components including laptops, computers, cameras, microphones, and speakers are in different areas of the room.

The USB-EX350-WPH-KIT is comprised of two endpoints. The host wallplate includes a USB-C port for hosts such as laptops, computers, or other AV equipment that support USB connectivity. The device endpoint includes three USB-A ports and one USB-C port for connection to 4K cameras, conferencing bars, microphones, speakers, and other peripherals. The entire kit is powered by a single power supply connected to the device endpoint.

The USB-EX350-WPH-KIT is a great solution for routing USB 3.2 Gen 1 data up to 5 Gbps between peripherals at distances greater than is possible with traditional cabling.

Features

- Point-to-point USB extender kit for devices such as cameras, speakers, microphones and other peripherals.
- Extends USB 3.2 Gen 1 and USB 2.0 data simultaneously up to 330 feet (100 meters) using a single Category 6A U/FTP cable.
- Supports USB 3.2 Gen 1 data rates up to 5 Gbps.
- Supports USB 2.0 data rates up to 480 Mbps.
- One USB-C interface for host connection on the host wallplate.
- Three USB-A and one USB-C for peripheral connections on the device endpoint.
- Kit is powered from the device endpoint, allowing a single cable connection for data and power to the host wallplate.
- LAN port for configuration, monitoring, and control.
- Configurable VBUS mode for each USB peripheral port on the device endpoint.
- IP to RS-232 translation for bi-directional RS-232 communications through the device endpoint.
- US one-gang host wallplate - interchangeable white and black trim kits.
- Compact host endpoint enclosure can be mounted in furniture, behind a display, or above a projector.
- Each peripheral port provides up to 1.5 amps (3.2 amps total) allowing even energy-hungry components to be powered by the device endpoint.
- Kit includes host wallplate, white and black trim kits, device endpoint, power supply, and mounting brackets.

Package Contents

1 x AT-USB-EX350-HS-WP
1 x AT-USB-EX350-DV
1 x White wall plate
1 x Black wall plate
1 x 48 V / 1.36 A power supply
1 x QR card

Panel Description

AT-USB-EX350-HS-WP

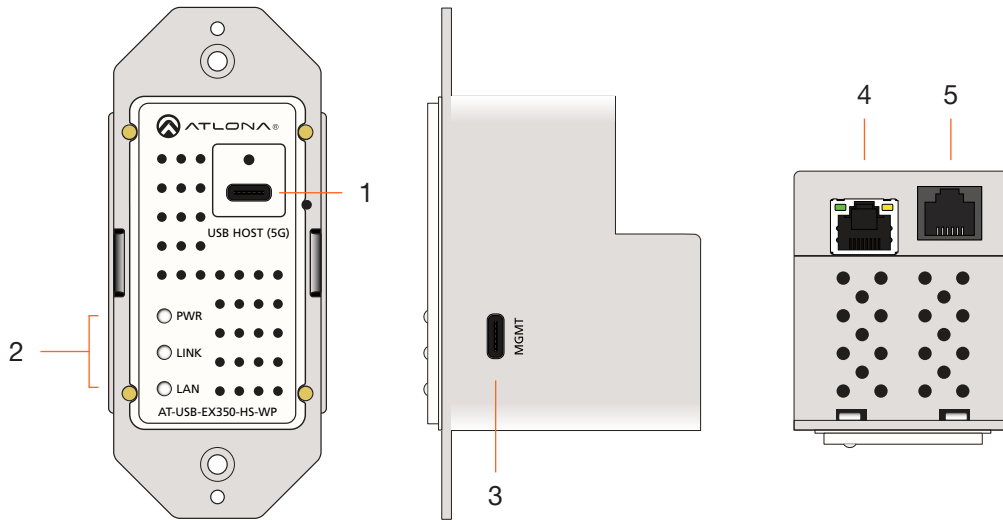

1 USB HOST (5G)

Connect the included USB-C cable from this port to the host device.

2 LED Indicators

The **PWR** LED indicator will be green while the unit is powered and operating normally. The **LINK** LED indicator will be green when the HDBT-USB3 link is normal. The **LAN** LED indicator will be green when the wallplate is connected to a LAN. Refer to [LED Indicators \(page 12\)](#) for more information.

3 MGMT

Connect a USB-C cable from this port to a computer to perform firmware updates. Refer to [Updating the Firmware \(page 50\)](#) for more information.

4 LAN

Connect an Ethernet cable from this port to a network switch on the Local Area Network (LAN). This connection is required in order to access the built-in web server.

5 HDBT-USB3

Connect a category cable (CAT6A U/FTP), up to 330 feet (100 meters), from this port to the **HDBT-USB3** port on the AT-USB-EX350-DV.

AT-USB-EX350-DV

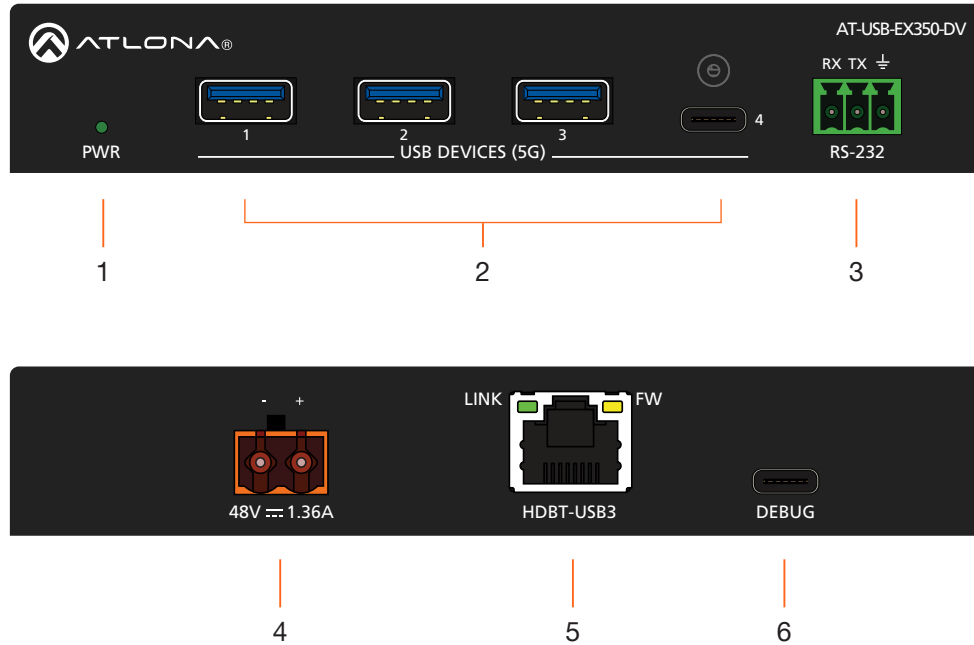

1 PWR

This LED indicator will be green while the unit is powered and operating normally. Refer to [LED Indicators \(page 12\)](#) for more information.

2 USB DEVICES (5G)

Connect USB devices to these ports. Each port supports USB 3.2 Gen 1 and 5 V / 1.5 A of output power. The USB-C port supports USB 3.0 and also provides 5 V / 1.5 A of output power.

3 RS-232

Connect an RS-232 cable from this port to a third-party device to enable TCP proxy through the **LAN** port on the host endpoint.

4 48V / 1.36A

Connect the 2-pin captive screw connector on the included power supply to this power receptacle.

5 HDBT-USB3

Connect a category cable (CAT6A U/FTP), up to 330 feet (100 meters), from this port to the **HDBT-USB3** port on the AT-USB-EX350-HS-WP.

6 DEBUG

Connect a USB-C cable from this port to a computer for debugging and for performing Valens firmware updates.

Installation

Connection Instructions

1. Connect a USB cable from the host device to the **USB-C HOST (5G)** port on the AT-USB-EX350-HS-WP. This port supports USB 3.2 data up to 5 Gbps and USB 2.0 data up to 480 Mbps.

Recommended cable types:

- USB Type-A to Type-C (USB 3.2 Gen 1 or higher)
- USB Type-C to Type-C (USB 3.2 Gen 1 or higher)

2. Connect up to four USB devices to the **USB DEVICES (5G)** ports on the AT-USB-EX350-DV. Each port supports USB 3.2 Gen 1 and delivers 5 V / 1.5 A of power.
3. Connect a CAT6A U/FTP cable from the **HDBT-USB3** port on the AT-USB-EX350-HS-WP to the **HDBT-USB3** port on the AT-USB-EX350-DV. The cable must not exceed 330 ft (100 m).
4. Connect an Ethernet cable from the **LAN** port on the AT-USB-EX350-HS-WP to the network. This connection is required to access the built-in web server for controlling and configuring the AT-USB-EX350-WPH-KIT.
5. OPTIONAL: Connect a 3-pin captive screw connector from the **RS-232** port on the AT-USB-EX350-DV to a third-party device to enable TCP proxy via LAN control at the host endpoint.
6. Connect the included power supply to the **48 V / 1.36 A** power receptacle on the AT-USB-EX350-DV.
7. Connect the power cord to an available AC outlet.

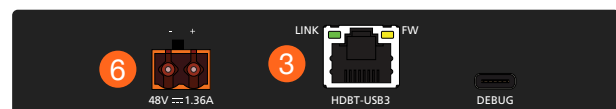
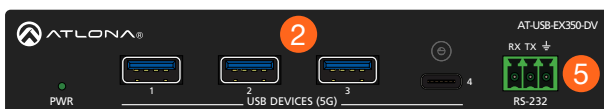
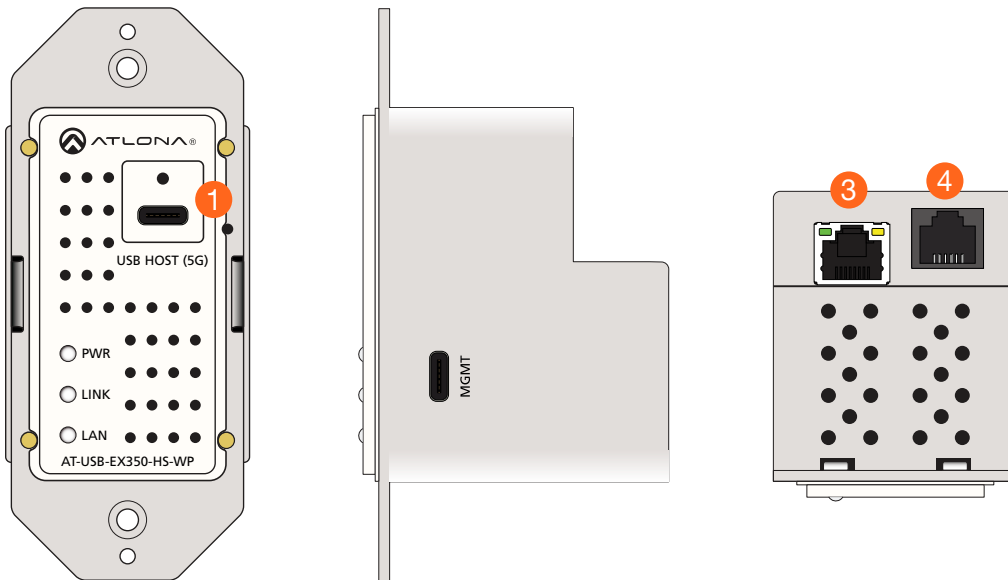

Connection Diagram

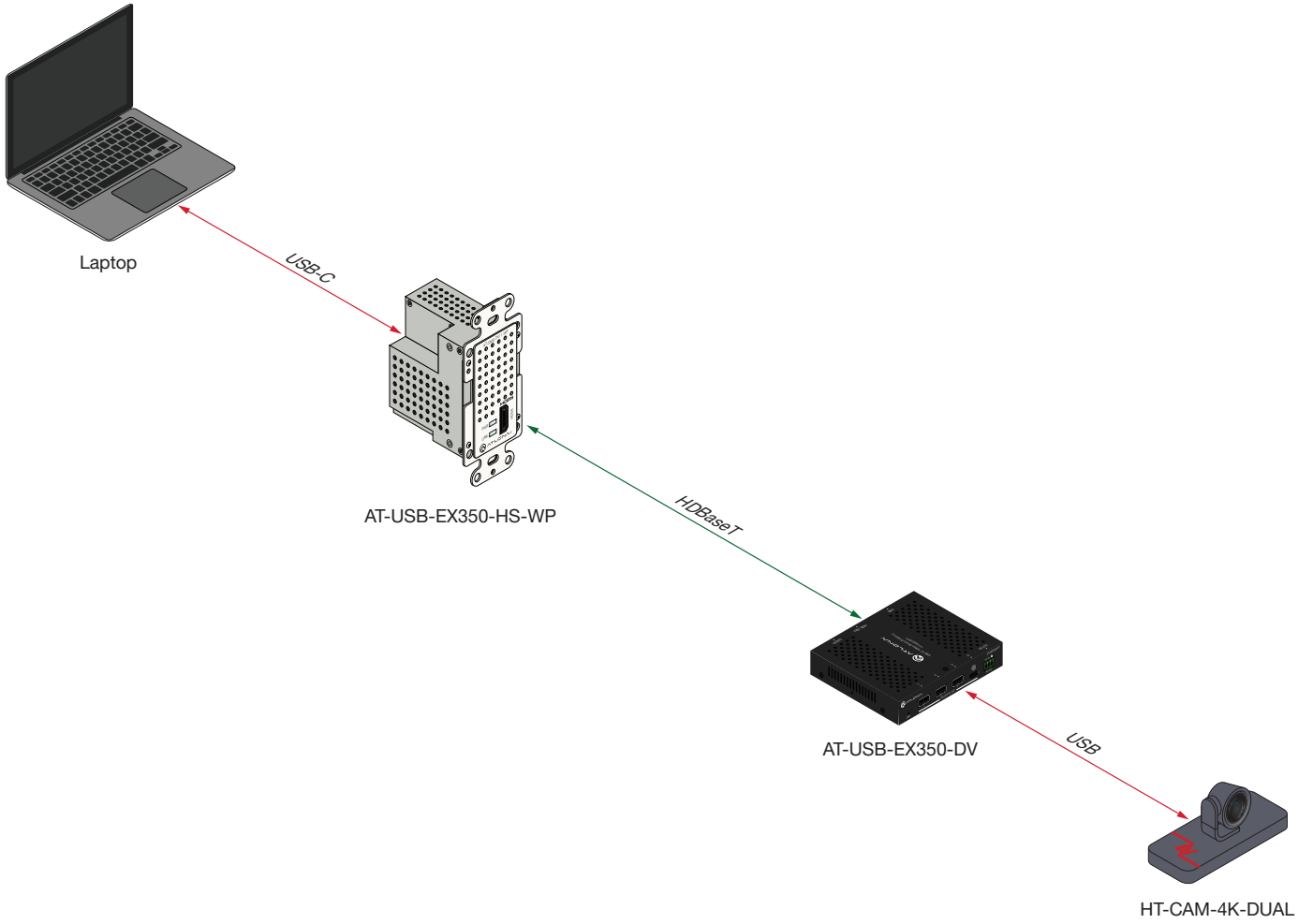

IP Configuration

The AT-USB-EX350-WPH-KIT is shipped with DHCP enabled. Once connected to a network, the DHCP server (if available), will automatically assign an IP address to the unit. If the AT-USB-EX350-WPH-KIT is unable to detect a DHCP server within 15 seconds, then the unit will use a self-assigned IP address within the range of 169.254.xxx.xxx/16. If this occurs, refer to the instructions below. Otherwise, skip to the next page.

Automatic Private IP Addressing (APIPA) Mode

If the AT-USB-EX350-WPH-KIT is unable to detect a DHCP server within 15 seconds, when set to DHCP mode, then Automatic Private IP Addressing (APIPA) will be used to assign an address within the IPv4 address block 169.254.xxx.xxx/16. If a DHCP server is detected while in APIPA mode, then the AT-USB-EX350-WPH-KIT will be assigned an address from the DHCP server pool. To manually configure the IP address, connect an Ethernet cable directly from the **LAN** port of the Host Endpoint of the AT-USB-EX350-WPH-KIT to the LAN port of a computer, then do the following:

1. Change the IP address of the computer to an unused IP address within the range 169.254.xxx.xxx/16. *The computer must not be assigned the same address as the AT-USB-EX350-WPH-KIT.*
2. Click **Start > Settings > Control Panel > Network and Sharing Center**.
3. Click **Change adapter settings**.
4. Right-click on the adapter that is used to establish a wired connection to the network, and select **Properties** from the context menu.
5. Under the **Ethernet Properties** dialog box, select **Internet Protocol Version 4** and then click the **Properties** button. Click the **Use the following IP address** radio button.





IMPORTANT: Before continuing, write down the current IP settings in order to restore them, later. If **Obtain an IP address automatically** and **Obtain DNS server automatically** are selected, then this step is not required.



6. Enter the desired static IP address or the IP address provided by the network administrator. If the computer does not require Internet access or if a statically-assigned IP address is being used, then an address within the IPv4 address block 169.254.xxx.xxx/16 can be entered.
7. Set the subnet mask to 255.255.0.0.
8. Click the **OK** button then close all **Control Panel** windows.
9. Log in to the built-in web server to set a static IP address that can be used with the network. Contact a system administrator, if necessary. Refer to [Setting the IP Mode \(page 18\)](#) for more information.



Device Operation



LED Indicators



The **PWR** indicator on both the AT-USB-EX350-HS-WP and AT-USB-EX350-DV displays their respective power states.

PWR		Description
Solid green		Unit is powered.
Off		Unit is not powered. <ul style="list-style-type: none"> Verify that the 2-pin captive screw connector is firmly secured to the 48V / 1.36A power receptacle on the AT-USB-EX350-DV. Make sure that the power supply is plugged into a live AC outlet.

LINK (front of wallplate only)		Description
Solid green		Link exists between host and device endpoints.
Off		Link does not exist between host and device endpoints or device is not powered. <ul style="list-style-type: none"> Verify that there is a category cable connecting the two endpoints. If a cable is connecting the two units, check to confirm that the cable is correctly terminated on both ends. Verify that the system is powered.

LAN (front of wallplate only)		Description
Solid green		Link exists between host and LAN.
Off		Link does not exist between host and LAN. <ul style="list-style-type: none"> Verify that there is an Ethernet cable connected to the LAN. If an Ethernet cable is connected, check to confirm that the cable is correctly terminated on both ends.

LINK (RJ45)		Description
Solid green		Link exists between host and device endpoints.
Off		Link does not exist between host and device endpoints or device is not powered. <ul style="list-style-type: none"> Verify that there is a category cable connecting the two endpoints. If a cable is connecting the two units, check to confirm that the cable is correctly terminated on both ends. Verify that the system is powered.

FW (RJ45)		Description
Blinking amber		1 Hz (slow) blinking amber: unit is booted and operating normally.
Blinking amber		5 Hz (rapid) blinking amber: Valens FW has an issue. Contact Atlona Technical Support.
Off		Unit is not powered or Valens FW did not load. <ul style="list-style-type: none"> Verify that the system is powered. If it is powered and this LED is off, contact Atlona Technical Support.

RS-232 Control

Connect an RS-232 cable from the RS-232 port on the AT-USB-EX350-DV to a device that will be controlled via a serial connection, such as a camera. This connection will be established over the network using a TCP Proxy to the AT-USB-EX350-HS-WP.

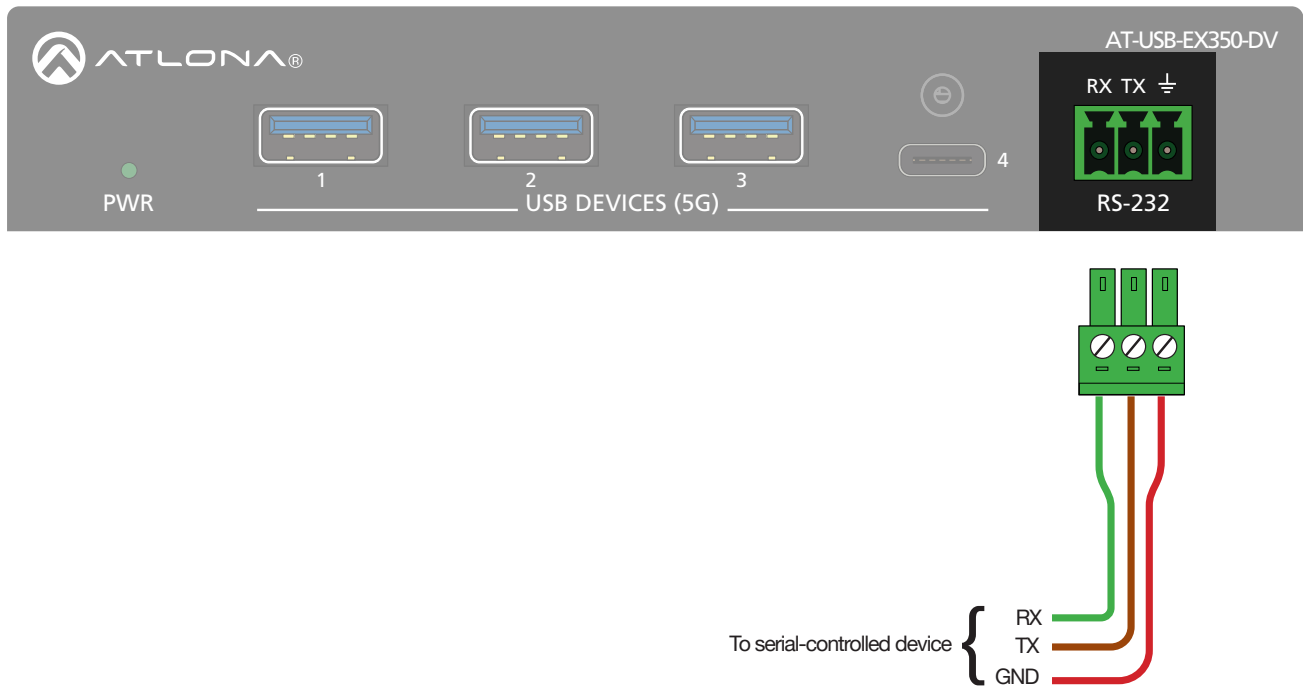

Logging in to the Web Server

Most of the AT-USB-EX350-WPH-KIT operation is handled through the built-in web server. In order to access the web server, the IP address of the unit must be known.

Login Registration

Before the built-in web server can be accessed the password must be changed.

1. Launch the desired web browser and enter the IP address of the AT-USB-EX350-DV in the address bar.
2. The **Login** page will be displayed.

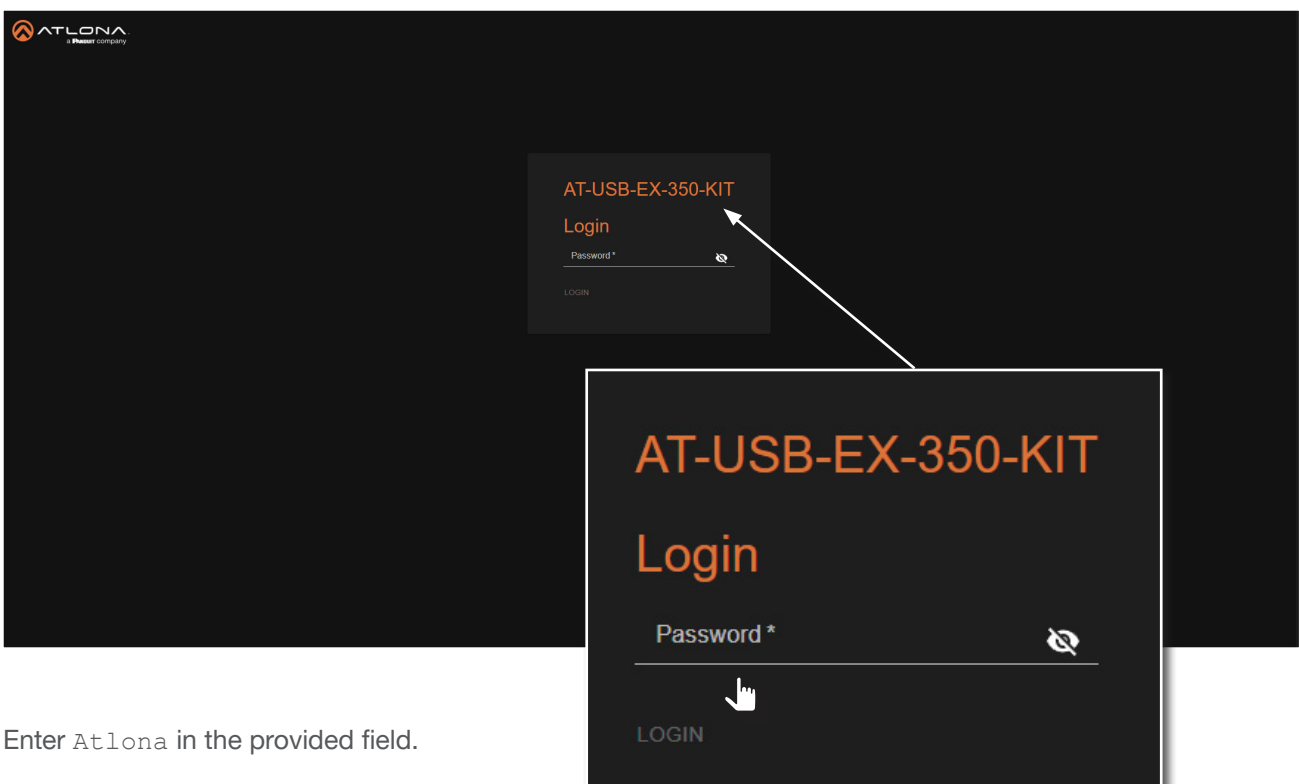

3. Enter `AtLona` in the provided field.
4. Click the **LOGIN** button.
5. The **Change Password** screen will be displayed.

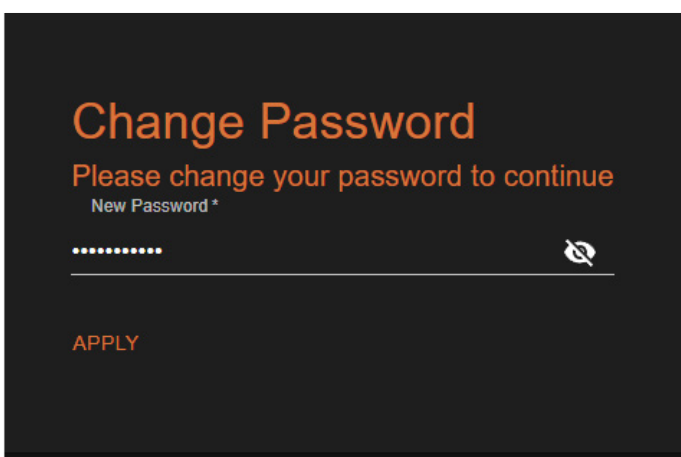

6. Enter the desired password in the **Password** field. By default, the password will be masked. To toggle between password masking and unmasking, click the  icon.



NOTE: Passwords can be 5 to 32 characters in length and can only contain letters, numbers, dashes, underscores, and periods. The password that is created is referred to as the *Admin* password. Additional users cannot be created or assigned. This password can be changed, if desired, from within the web server. Refer to [Changing the Administrator Password \(page 17\)](#) for more information.

7. Click the **Apply** button to commit changes.
8. The **System > System** page will be displayed.

Logging in after Registration

1. Launch the desired web browser and enter the IP address of the AT-USB-EX350-WPH-KIT in the address bar.
2. Enter the correct password in the provided field.
3. Click the **LOGIN** button.

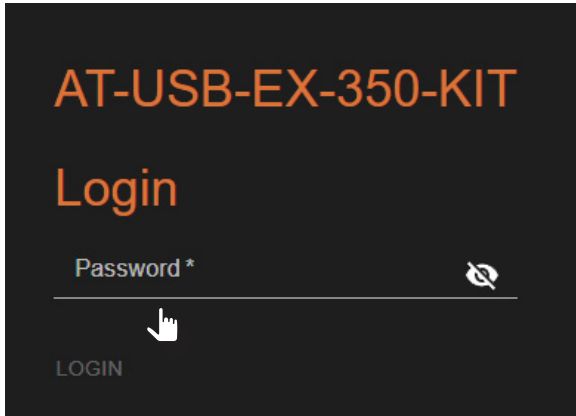

4. The **System > System** page will be displayed.

System Settings

The AT-USB-EX350-WPH-KIT provides easy access to system configuration through the built-in web server and is the recommended method to adjust network settings.

Obtaining System Information

1. Log in to the web server.
2. Click **System** in the side menu bar.
3. Click **System** in the top menu bar.
4. Locate the **Info** window group to obtain the IP address, MAC address, System Time, Temperature, and various other details about the AT-USB-EX350-WPH-KIT.

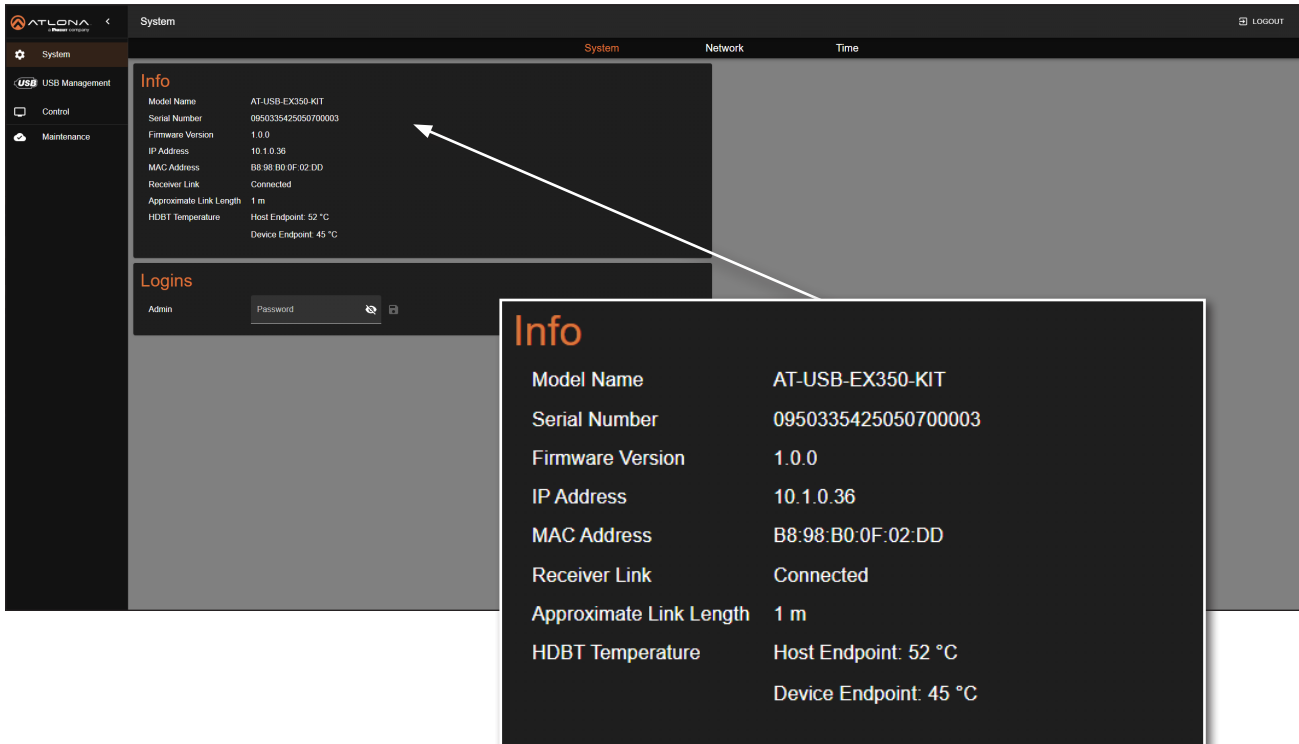

The screenshot displays the web interface for the AT-USB-EX350-WPH-KIT. The interface is divided into several sections: a left sidebar with navigation options (System, USB Management, Control, Maintenance), a top navigation bar (System, Network, Time), and a main content area. The main content area is currently displaying the 'System' page, which includes an 'Info' section and a 'Logins' section. The 'Info' section provides the following details:

Info	
Model Name	AT-USB-EX350-KIT
Serial Number	0950335425050700003
Firmware Version	1.0.0
IP Address	10.1.0.36
MAC Address	B8:98:B0:0F:02:DD
Receiver Link	Connected
Approximate Link Length	1 m
HDBT Temperature	Host Endpoint: 52 °C Device Endpoint: 45 °C

The 'Logins' section shows a login form with the username 'Admin' and a password field. A white arrow points from the 'Info' section in the main content area to a larger, detailed view of the 'Info' section shown in the foreground.

Changing the Administrator Password

1. Log in to the web server.
2. Click **System** in the side menu bar.
3. Click **System** in the top menu bar.
4. Locate the **Logins** window group.

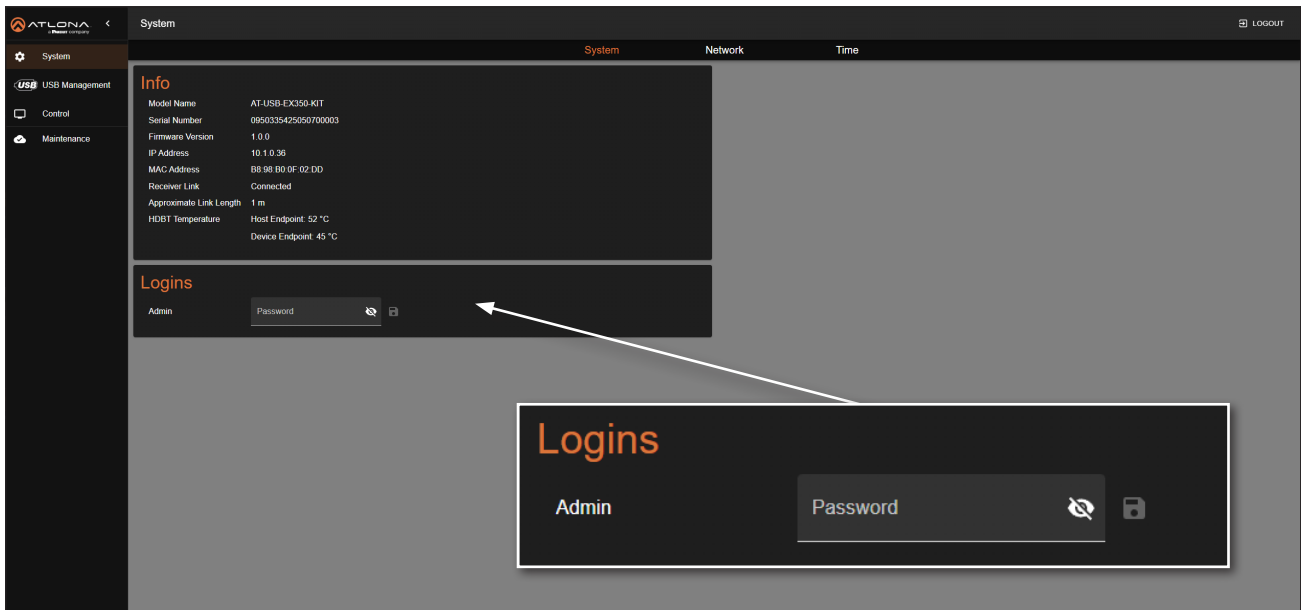

5. Enter the new password in the **Admin** field. By default, the password will be masked. To toggle between password masking and unmasking, click the  icon.

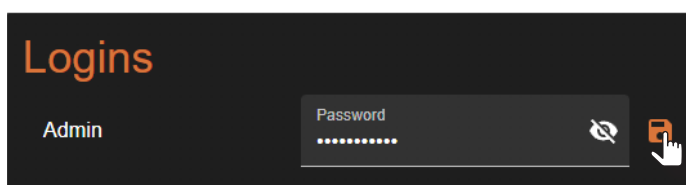

6. Click the  icon to commit changes.

Network Configuration

Setting the IP Mode

The AT-USB-EX350-WPH-KIT is set to DHCP by default and will receive an IP address from the network's DHCP pool if a DHCP server is available. If no DHCP server is detected, the AT-USB-EX350-WPH-KIT will automatically assign itself an APIPA address in the range 169.254.xxx.xxx/16. A static IP address can also be specified.



IMPORTANT: Before assigning a static IP address to the AT-USB-EX350-WPH-KIT, it is recommended to consult with the network or system administrator and obtain an available IP address. Assigning the AT-USB-EX350-WPH-KIT to an IP address that is already in use can result in network issues or difficulty in accessing the AT-USB-EX350-WPH-KIT.

Static IP Mode

1. Log in to the web server.
2. Click **System** in the side menu bar.
3. Click **Network** in the top menu bar.
4. Locate the **Network** window group.
5. Click the **Type** drop-down list and select *Static*.

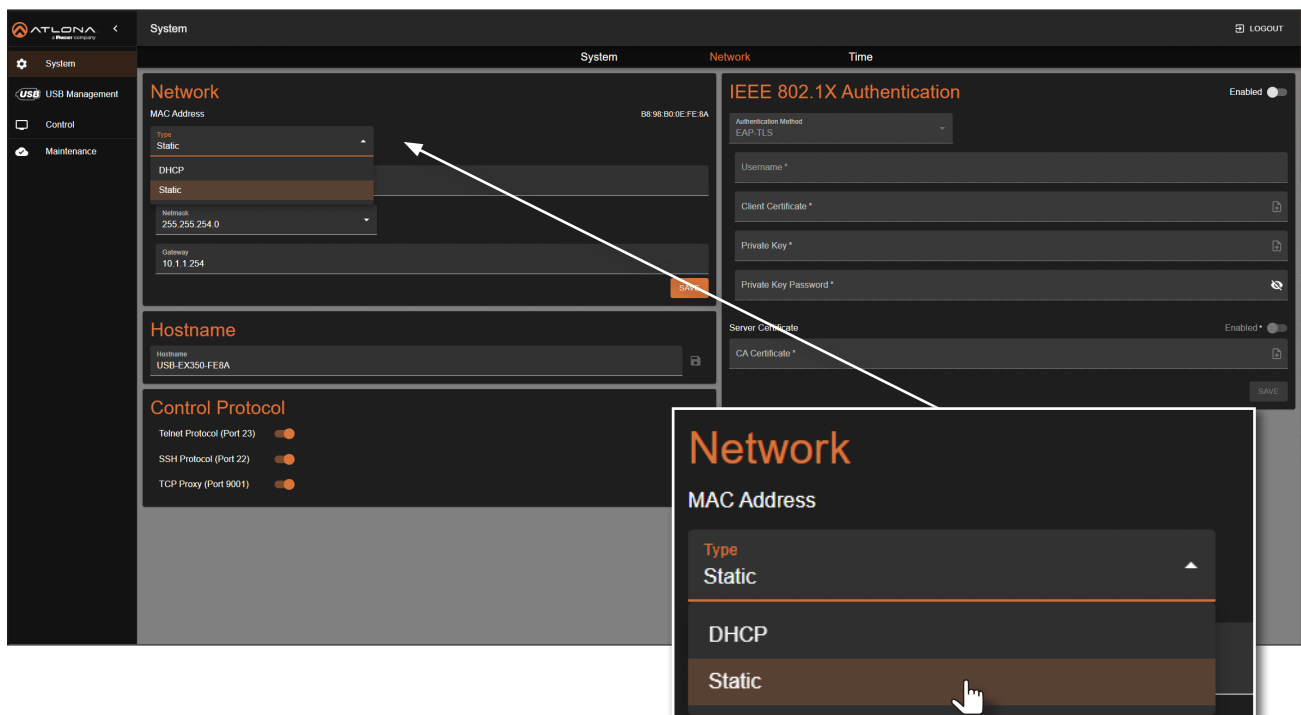

6. Enter IP address, network mask, and gateway (router) address in the **Address**, **Netmask**, and **Gateway** fields, respectively.
7. Click the **SAVE** button to commit changes.

DHCP Mode

The AT-USB-EX350-WPH-KIT is set to DHCP by default and will receive an IP address from the network's DHCP pool if a DHCP server is available. If no DHCP server is detected, the AT-USB-EX350-WPH-KIT will automatically assign itself an APIPA address in the range 169.254.xxx.xxx/16.

1. Log in to the web server.
2. Click **System** in the side menu bar.
3. Click **Network** in the top menu bar.
4. Locate the **Network** window group.
5. Click the **Type** drop-down list and select DHCP.

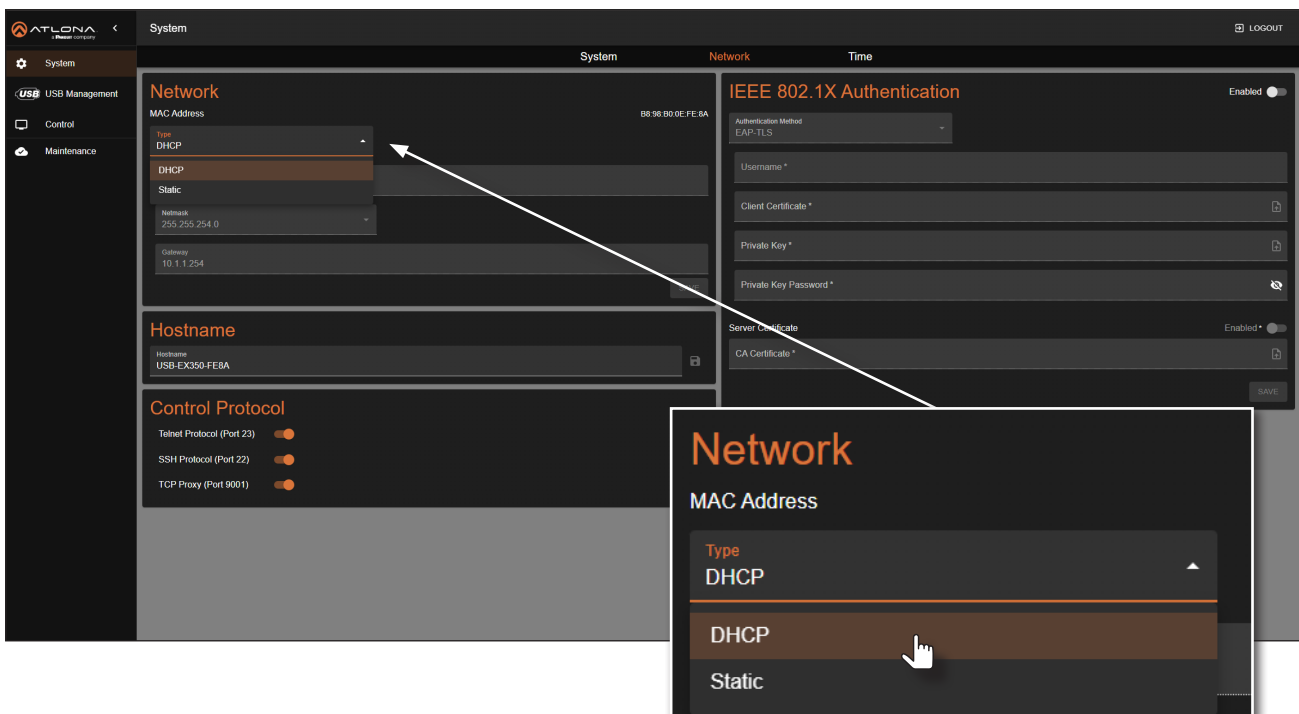

6. Click the **SAVE** button to commit changes. The assigned IP address will be shown in the web UI.

IEEE 802.1x Authentication

802.1x is a server-based port authentication which restricts unauthorized (rogue) clients from connecting to a Local Area Network. In its simplest form, 802.1x usually involves three parties: supplicant (client device), authenticator (Ethernet switch or WAP), and an authentication server. Before the device is permitted on the network, port communication is restricted to Extensible Authentication Protocol over LAN (EAPOL) traffic. If the device passes the authentication process, the authentication server notifies the switch, allowing the client to access the LAN. The illustration below shows the basic architecture.



IMPORTANT: If an 802.1x-enabled AT-USB-EX350-WPH-KIT is connected to a network without an active or operational authentication server, then the AT-USB-EX350-WPH-KIT will not function correctly until the expected message is returned from a RADIUS server. If it is unclear as to whether the network uses 802.1x authentication, consult the IT administrator for assistance.

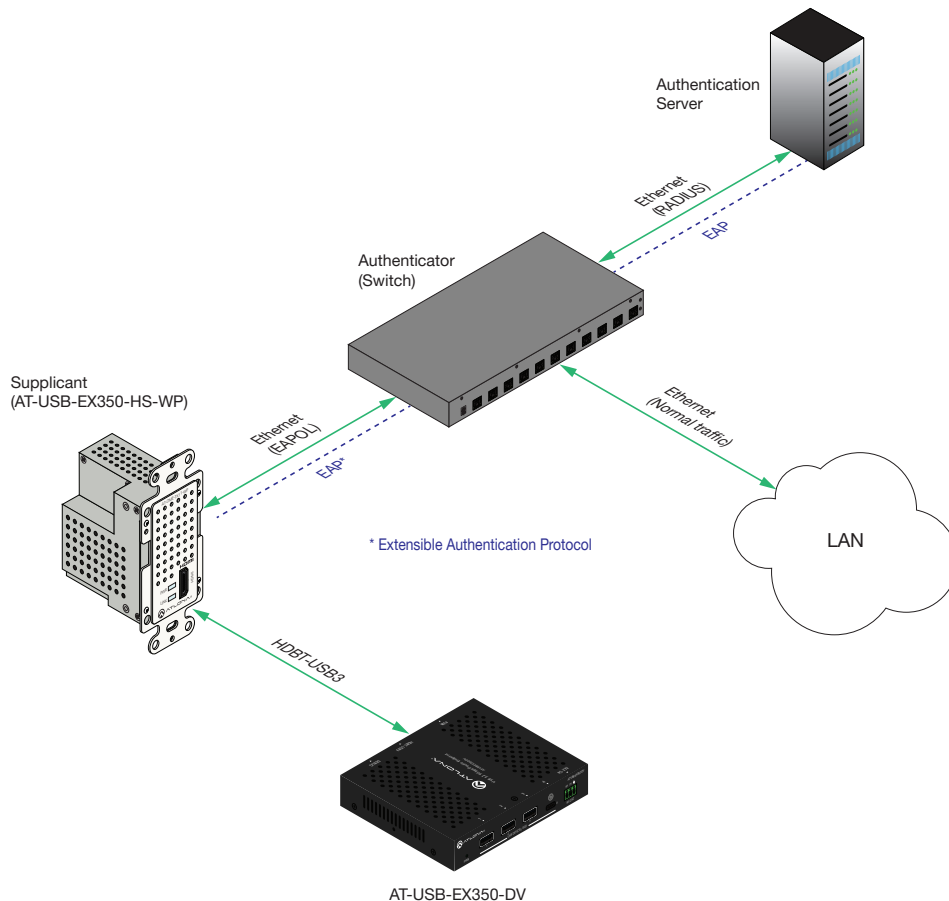

The following options are available:

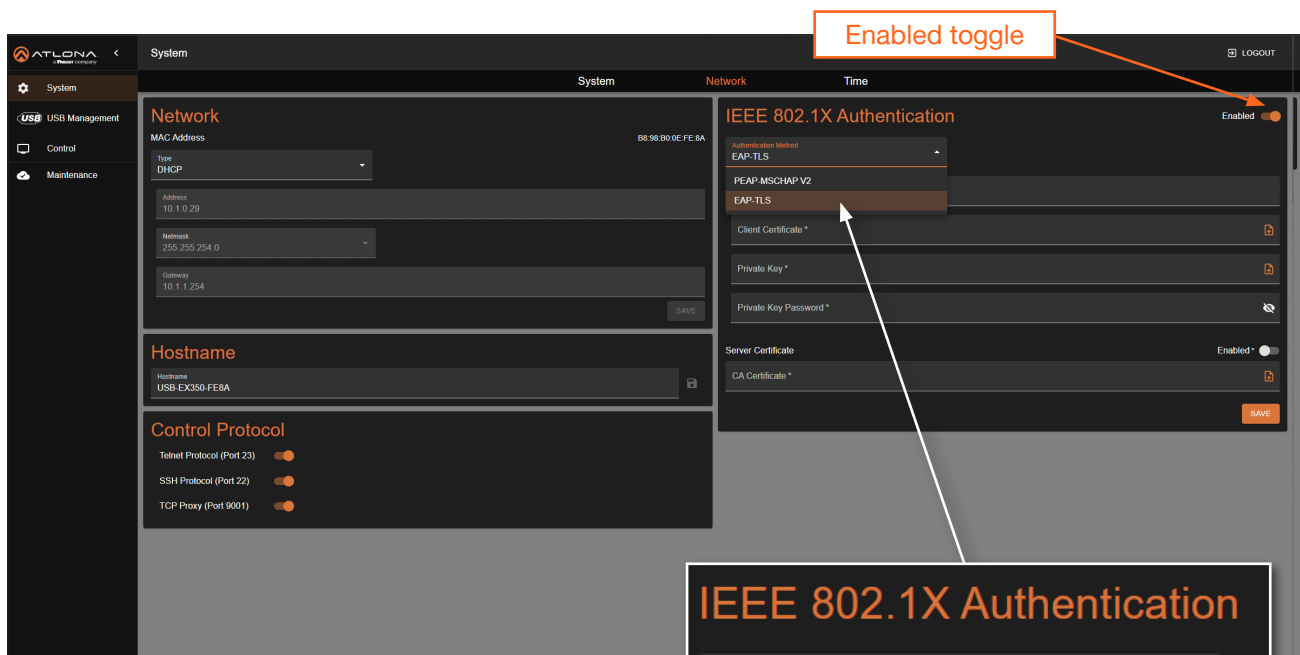

Protocol	Description
PEAP/MSCHAPv2	Protected EAP; uses basic credentials in addition to a CA (certificate authority) certificate.
EAP-TLS	EAP Transport Layer Security; uses a client certificate, private key, private key password, and CA (certificate authority) certificate.

1. Log in to the web server.
2. Click **System** in the side menu bar.
3. Click **Network** in the top menu bar.
4. Locate the **IEEE 802.1x Authentication** window group.
5. Click the **Enabled** toggle button. When IEEE 802.1X is enabled, the toggle will be orange.
6. Click the **Authentication Method** drop-down list and select the desired authentication method. In the example below, **EAP-TLS** is selected. Once a method is selected, the required fields for that method will be displayed. Enter the required information in each field.





7. Click the **SAVE** button to commit changes.

Depending upon the authentication method, each field is described as follows:

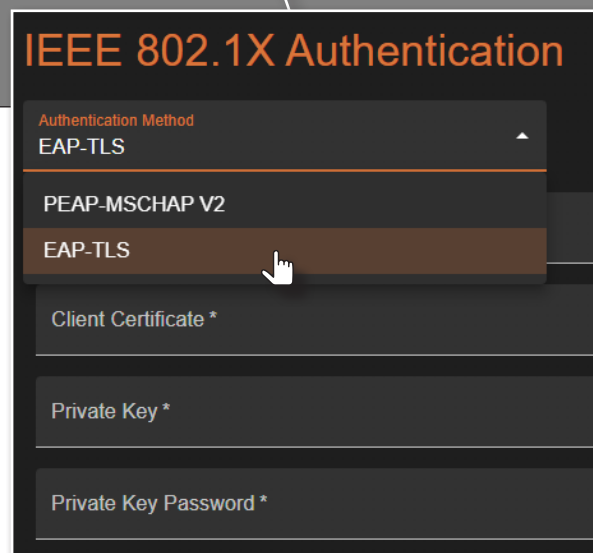
- **Username**
The identifier for the user or device that is attempting to connect to the network.
- **Password**
Enter the password in this field.
- **CA certificate**
A digital certificate issued by a Certificate Authority (CA) that serves as the foundation of trust for verifying other certificates, such as client certificates and server certificates. To upload the certificate, click the **Enabled** button, above the **Server Certificate** field, then click the  icon to select the certificate.
- **Client Certificate**
A digital certificate used to authenticate a device or user attempting to connect to the network. This is typically used in enterprise environments or when added security is desired. To upload the certificate, click the **Enabled** button, above the **Server Certificate** field, then click the  icon to select the certificate.



- Private Key**
 A component of the public key infrastructure (PKI) and associated with the digital certificate. This key is securely stored and used to prove identity and enable secure communication. Click the  icon to select the private key.
- Private Key Password**
 This password is designed as a level of security used to protect the private key, associated with a digital certificate. The password is masked by default. Click the  icon to toggle masking.

The table below provides a field summary. An orange dot indicates that this field will be displayed as part of the authentication method.

Authentication Method	Username	Password	CA Certificate	Client Certificate	Private Key	Private Key Password
PEAP/MSCHAPv2	●	●	●			
EAP-TLS	●		●	●	●	●

Setting the Host Name

By default, the AT-USB-EX350-WPH-KIT is assigned the following hostname: USB-EX350-[Last four digits of MAC address].

This value can be changed to easily identify the AT-USB-EX350-WPH-KIT within Velocity Device Manager or on a network. The hostname cannot exceed 15 characters in length.

1. Log in to the web server.
2. Click **System** in the side menu bar.
3. Click **Network** in the top menu bar.
4. Locate the **Hostname** window group.
5. Click the **Hostname** field and enter the desired name.

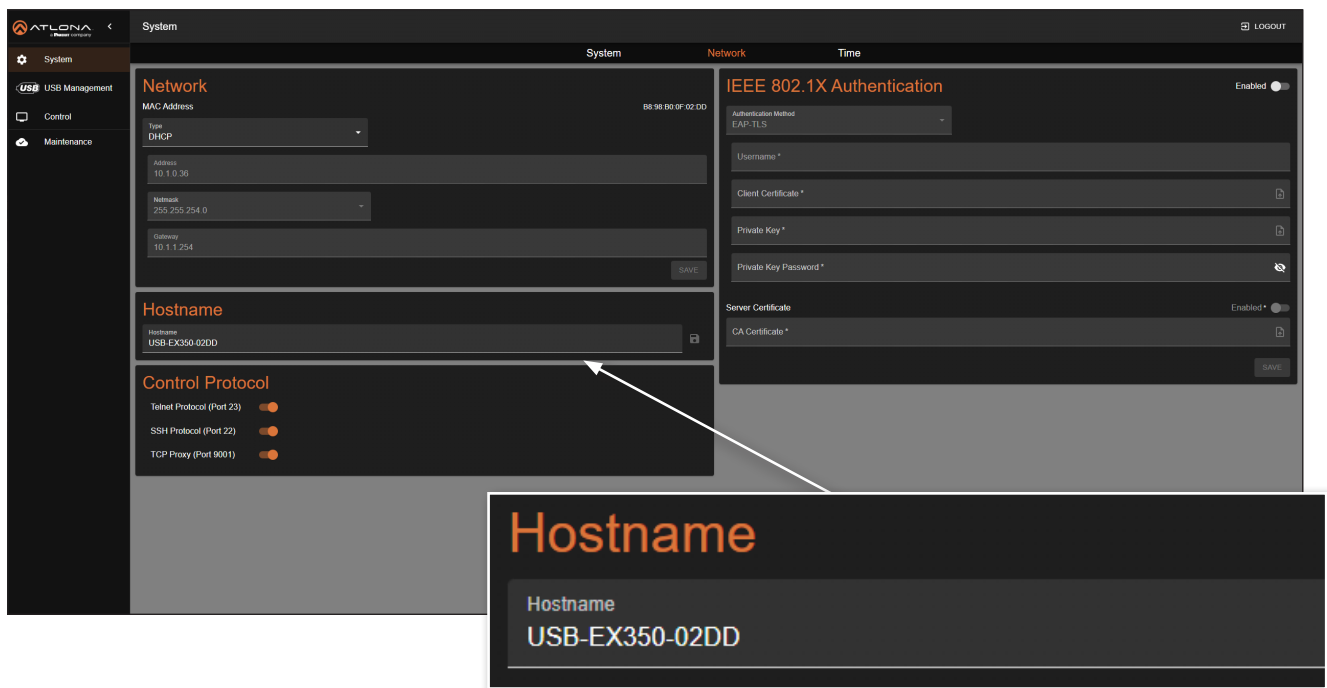

6. Click the  icon to commit changes.

System Time

The AT-USB-EX350-WPH-KIT uses an internal clock to store the current date and time.

Setting the Time Zone

1. Log in to the web server.
2. Click **System** in the side menu bar.
3. Click **Time** in the top menu bar.
4. Locate the **Time Zone** window group.
5. Click the  icon to display the list of time zones. Set the desired time zone by clicking it. Alternatively, the **Filter** field, within the drop-down list, can be used to filter various time zones from the list.

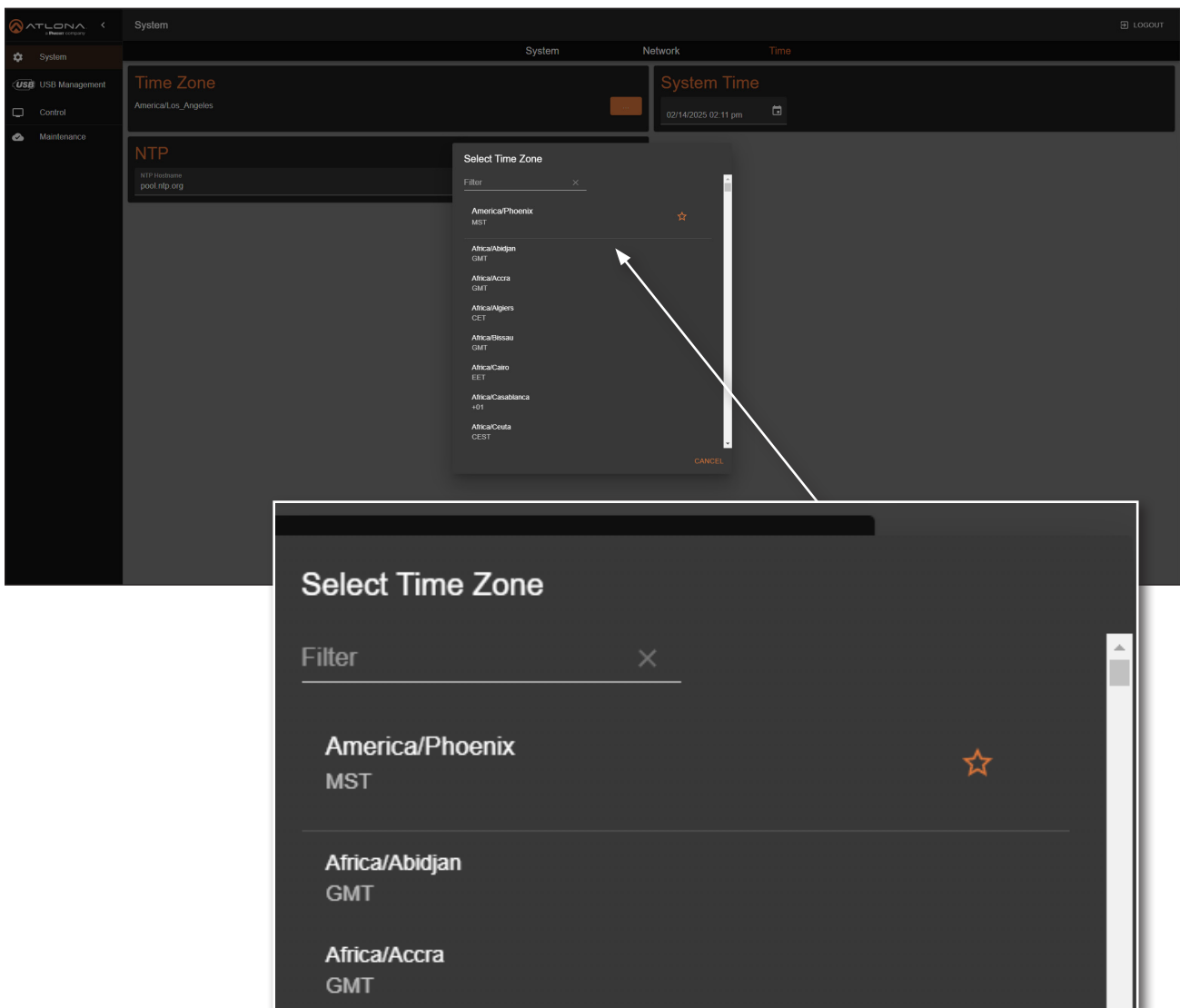

Assigning an NTP Server

If NTP is functioning correctly, then the date and time will be set automatically. The default server is `pool.ntp.org`.

1. Log in to the web server.
2. Click **System** in the side menu bar.
3. Click **Time** in the top menu bar.
4. Locate the **NTP** window group.
5. Click the **Enabled** toggle switch to enable NTP. When enabled, the toggle switch will be orange.
6. Enter the NTP server name.
7. Click the  icon to commit changes.

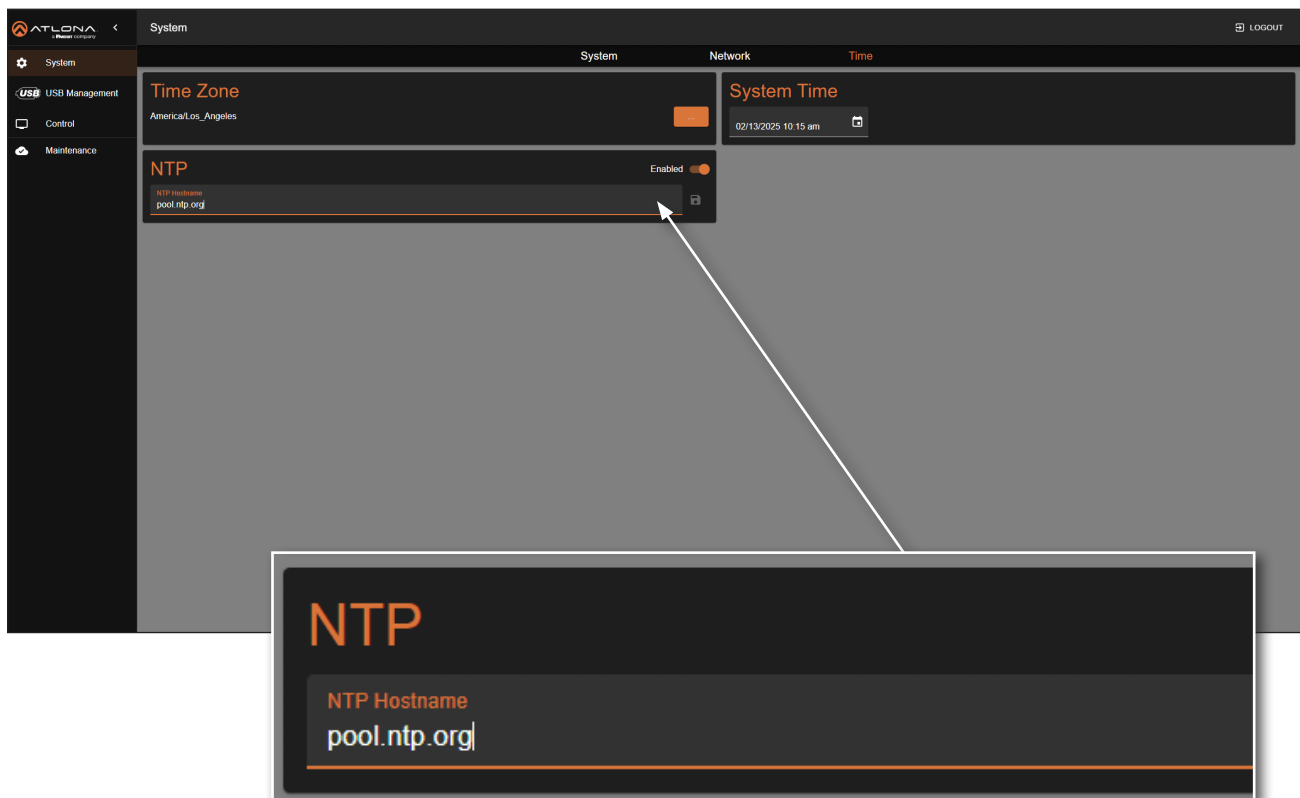

Setting the System Time

If an NTP server is not available, the system time can be set manually.

1. Log in to the web server.
2. Click **System** in the side menu bar.
3. Click **Time** in the top menu bar.
4. Locate the **NTP** window group and click the **Enabled** toggle button to disable NTP. When NTP is disabled, the toggle will be gray.

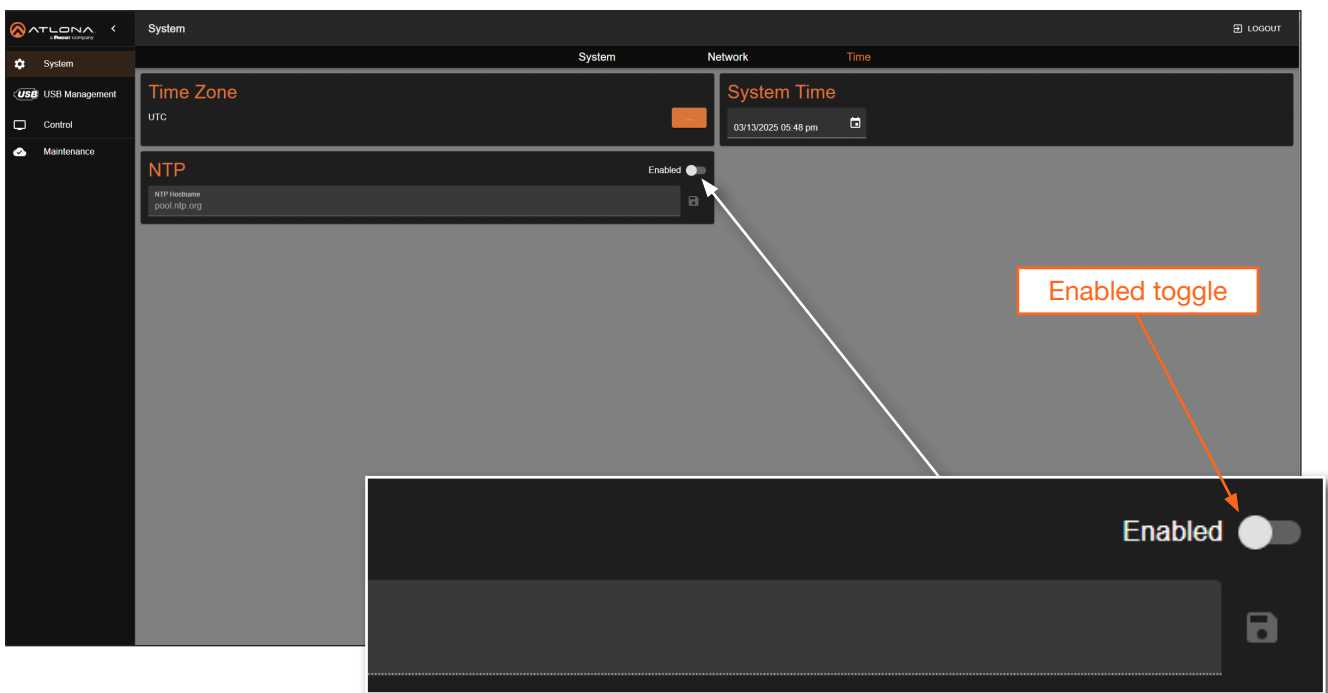

5. Locate the **System Time** window group.
6. Click the  icon to open up the time settings.

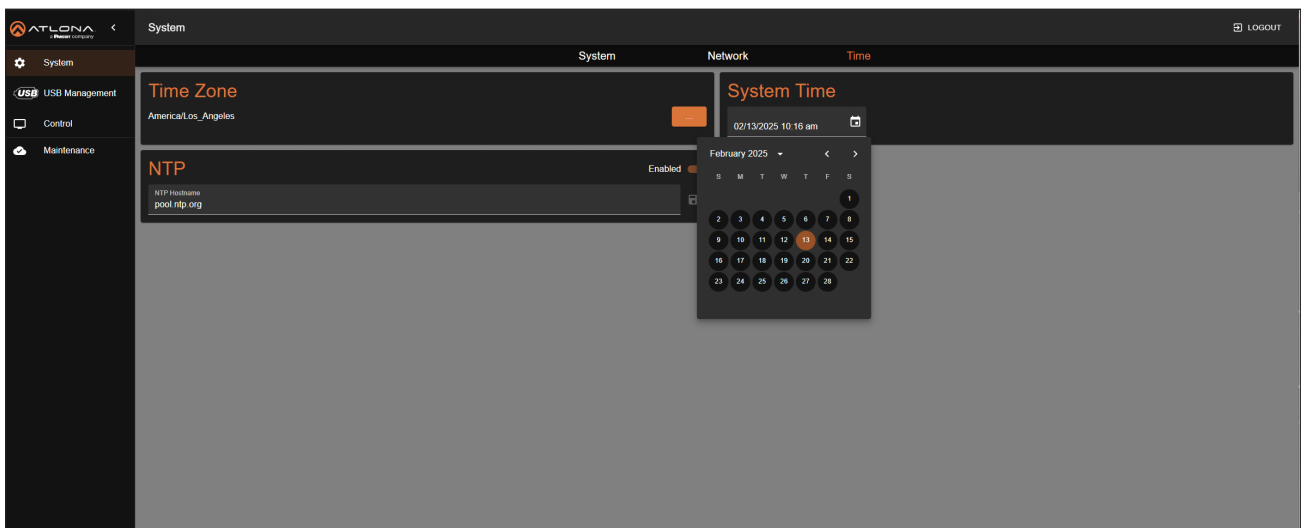

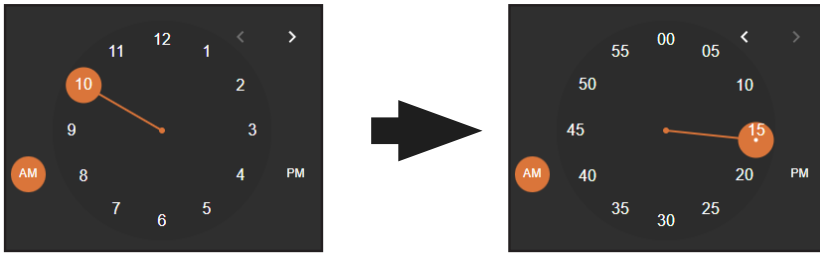

7. Click the correct date from the calendar widget. The currently set date will be highlighted in orange.
8. Click on **AM** or **PM** and then select the correct hour from the clock widget, then click the correct minute from the next widget that is displayed.
Alternatively, the time and date can also be entered using the keyboard, within the **System Time** field.

USB Management

This section covers USB device power control and information on USB topology.

USB Configuration

The AT-USB-EX350-WPH-KIT provides three different device power modes for the USB VBUS +5V power supply, which is the standard power supply voltage provided through a USB connection to power devices or charge batteries. Three modes are provided for each **USB DEVICES (5G)** port: *Follow USB Host*, *Always High*, and *Always Low*.

1. Log in to the web server.
2. Click **USB Management** in the side menu bar.
3. Click **USB Configuration** in the top menu bar.
4. Click the **Device Port [1...4] Vbus (5V)** drop-down list to select the desired mode.

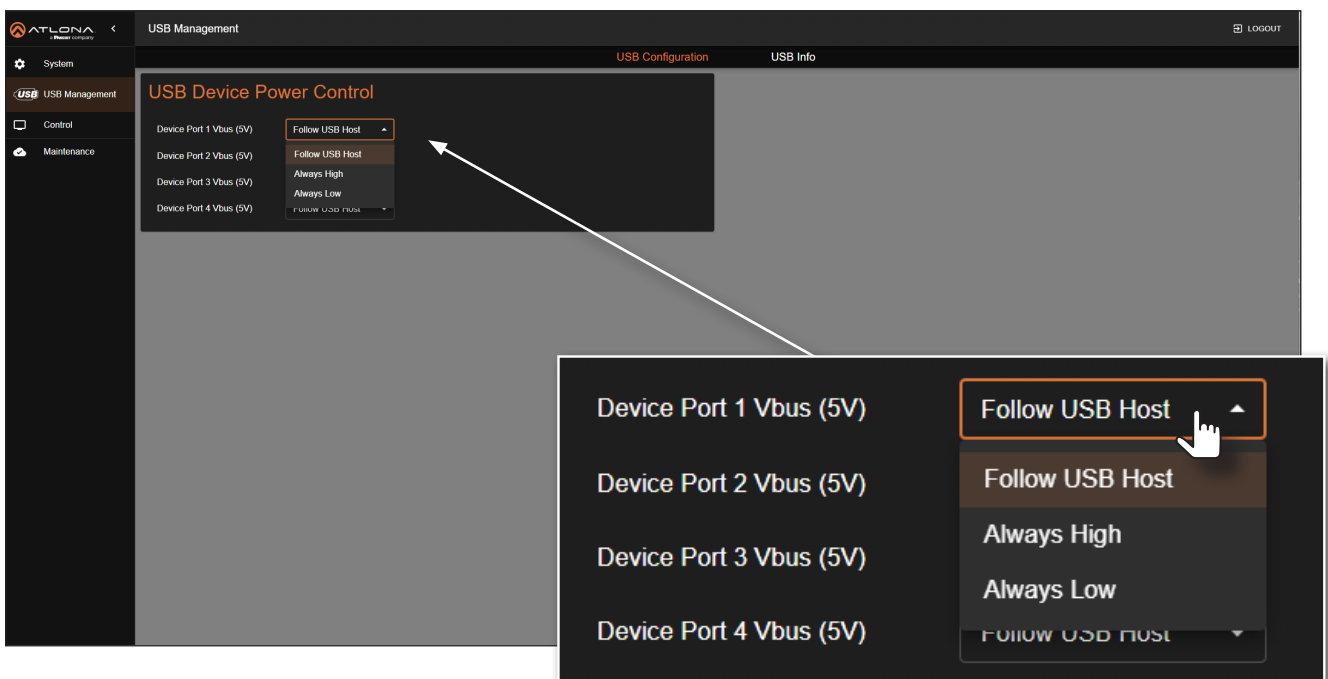

Setting	Description
Follow USB Host	Allows the USB hub port to toggle on and off based on the presence of a USB host.
Always High	USB power is always enabled. For example, when connecting to a battery-powered speakerphone, selecting <i>Always High</i> ensures that the speakerphone continues to charge even when no USB host is connected.
Always Low	USB power is disabled on the port.

USB Info

The AT-USB-EX350-WPH-KIT provides information about the USB port and the devices connected to them. This information is available via the web pages to provide visibility into the USB system.

1. Log in to the web server.
2. Click **USB Management** in the side menu bar.
3. Click **USB Info** in the top menu bar.

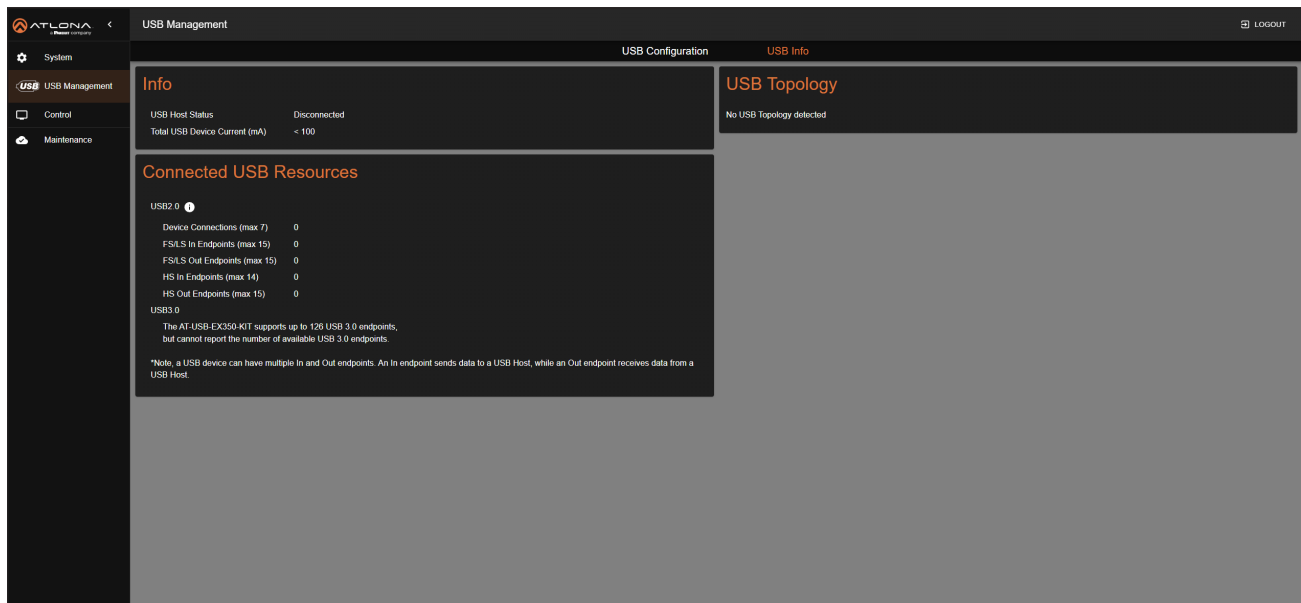

Info

This section enables users to verify if the USB host and device ports are connected to devices and to monitor the total output current of the USB device ports.



Connected USB Resources

This section provides an overview of available USB resources.

Connected USB Resources

USB2.0 ⓘ

Device Connections (max 7)	0
FS/LS In Endpoints (max 15)	0
FS/LS Out Endpoints (max 15)	0
HS In Endpoints (max 14)	0
HS Out Endpoints (max 15)	0

USB3.0

The AT-USB-EX350-KIT supports up to 126 USB 3.0 endpoints, but cannot report the number of available USB 3.0 endpoints.

*Note, a USB device can have multiple In and Out endpoints. An In endpoint sends data to a USB Host, while an Out endpoint receives data from a USB Host.

USB 2.0:

- Displays the available USB 2.0 resources.
- Hover over the ⓘ icon to view additional details:
 - **Device Connections:** Indicates the number of USB 2.0 devices that can be connected. The maximum supported devices are **7**.
 - **FS/LS/HS In/Out Endpoints:** Displays the number of available **Full Speed (FS)**, **Low Speed (LS)**, and **High Speed (HS)** In/Out endpoints. The maximum supported endpoints are:
 - FS/LS In/Out Endpoints: Up to **15**.
 - HS In Endpoints: Up to **14**.

USB 3.0:

- The AT-USB-EX350-WPH-KIT supports up to **126 USB 3.0 endpoints**.

USB devices can be connected based on the displayed availability. If the value is **0**, then no additional USB devices can be connected.

Note:

- A single USB device may contain multiple **In and Out endpoints**:
 - **In endpoints** send data *to* the USB host.
 - **Out endpoints** receive data *from* the USB host.

USB 2.0 Speed Classifications:

- **FS (Full Speed):** Maximum transfer rate of **12 Mbps** (keyboards / mouse devices).
- **LS (Low Speed):** Maximum transfer rate of **1.5 Mbps** (audio interfaces and older USB peripherals).
- **HS (High Speed):** Maximum transfer rate of **480 Mbps** (hard drives and cameras).

USB Topology

When a host device is connected to a **USB HOST (5G)** port, its USB topology is displayed in this section. To get information on a specific device, click the desired port. In the example below, **[Port 1]: Device (USB2)** is selected.

USB Topology

🔊 HUB

- ↔ [Port 1]: Device (USB2)
- ↔ [Port 2]: Device (USB2)
- ↔ [Port 3]:
- ↔ [Port 4]:

USB2

Type	Device
USB Address	47
USB Speed	Full Speed
Vendor ID	1038
Product ID	12ec

RS-232 Control

RS-232 Control Settings

This section allows you to configure RS-232 parameters for controlling remote third-party devices through the **RS-232** port. These settings also enable the port to function as a TCP proxy.

1. Make sure that the third-party device is connected to the **RS-232** port on the AT-USB-EX350-DV.
2. Log in to the web server.
3. Click **Control** in the side menu bar. The **RS-232 Port** field will show the model of the connected device endpoint.
4. Click the **Baud Rate** drop down list to select the required baud rate. Available options are 9600, 19200, 38400, 57600, and 115200.
5. Click the **Parity**, **Data Bits**, and **Stop Bit** drop-down lists to set the required value. In most cases, these values will be NONE, 8, and 1, respectively.
6. To test the serial port settings, a serial command can be sent using the web pages. Enter the command in the **Command** field. The command can be in either ASCII or hexadecimal format. If the command is entered in hexadecimal format, click the **HEX** checkbox.

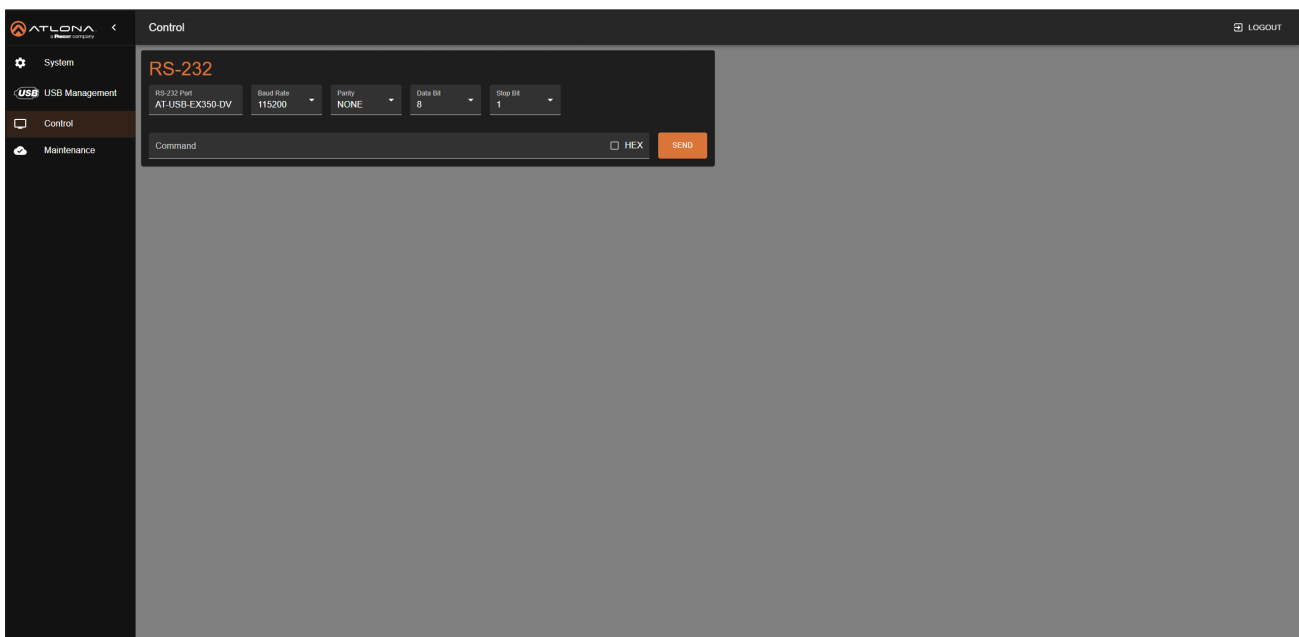

An example of an ASCII string might be: PWON.

A command in hexadecimal format might be:

```
\xBE\xEF\x03\x06\x00\xBA\xD2\x01\x00\x00\x60\x01\x00\x0D
```

7. Click the **SEND** button to verify that the command works properly.

System Maintenance

Updating the Firmware

1. Log in to the web server.
2. Click **Maintenance** in the side menu bar.
3. Click **System** in the top menu bar.

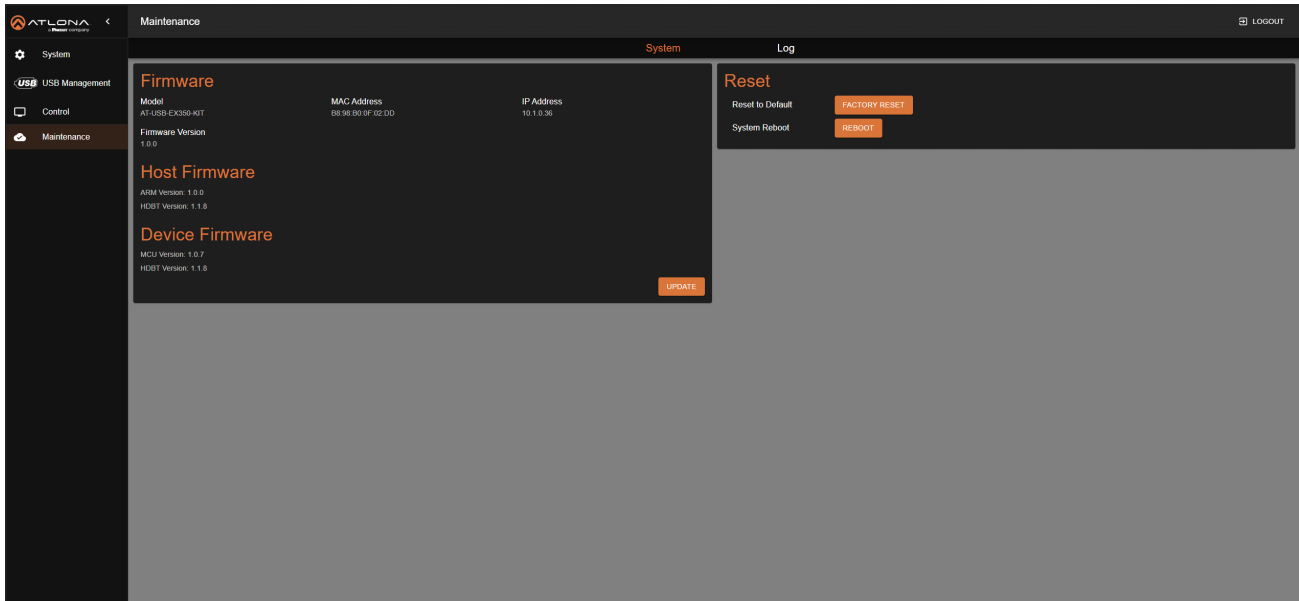

4. Click the **UPDATE** button. Refer to [Updating the Firmware \(page 50\)](#) for more information on updating the firmware.

Performing a Factory Reset

The AT-USB-EX350-WPH-KIT can be restored to factory-default settings through the built-in web server or by pressing the **RESET** button on the rear panel. After performing a factory reset, the network IP mode will be set to DHCP mode and the login credentials will be reset. A new password will need to be created.

1. Log in to the web server.
2. Click **Maintenance** in the side menu bar.
3. Click **System** in the top menu bar.
4. Locate the **Reset** window group.
5. Click the **FACTORY RESET** button.
6. The **Factory Reset** confirmation dialog will be displayed.
7. Click **FACTORY RESET** to continue with the process or click **CANCEL** to abort.
8. Once the unit has finished rebooting, repeat the procedure for creating a password. Refer to [Login Registration \(page 14\)](#) for more information.

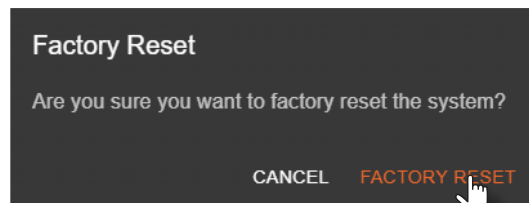

Rebooting the System

The following procedure will reboot the AT-USB-EX350-WPH-KIT. All network and other settings are preserved.

1. Log in to the web server.
2. Click **System** in the side menu bar.
3. Click **System** in the top menu bar.
4. Locate the **Operation** window group.
5. Click the **REBOOT** button.

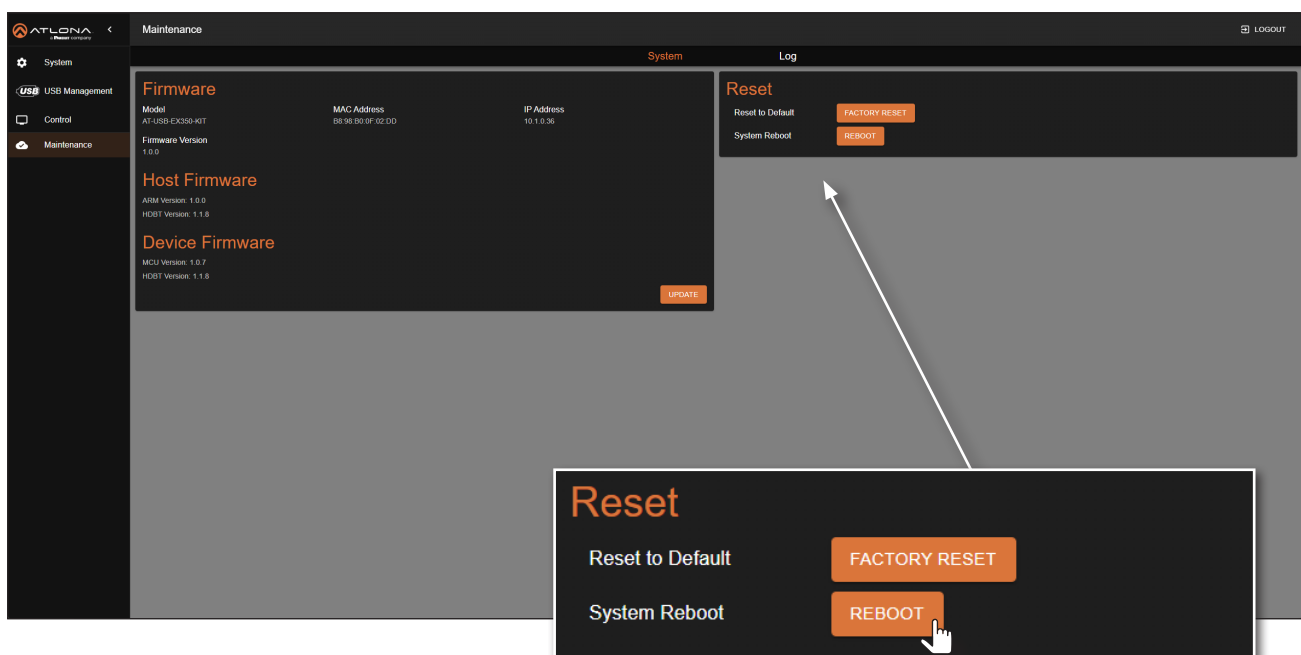

6. The **Reboot** confirmation dialog box will be displayed.

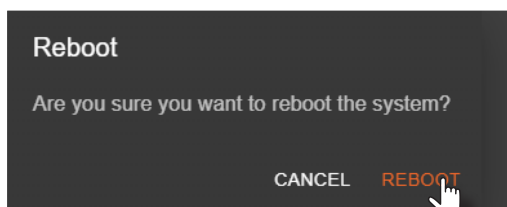

7. Click **REBOOT** to continue with the process or click **CANCEL** to abort.
8. Once the unit has finished rebooting, the **Login** screen will be displayed.

Downloading Log Files

This feature allows log files to be downloaded to the local PC. Log files are used for troubleshooting purposes and may be requested by Atlona Technical Support Engineers.

1. Log in to the web server.
2. Click **Maintenance** in the side menu bar.
3. Click **Log** in the top menu bar.
4. Under the Log Files window group, click the **DOWNLOAD** button. Log files are automatically downloaded to the C:\Users\[Username]\Downloads folder on the PC.

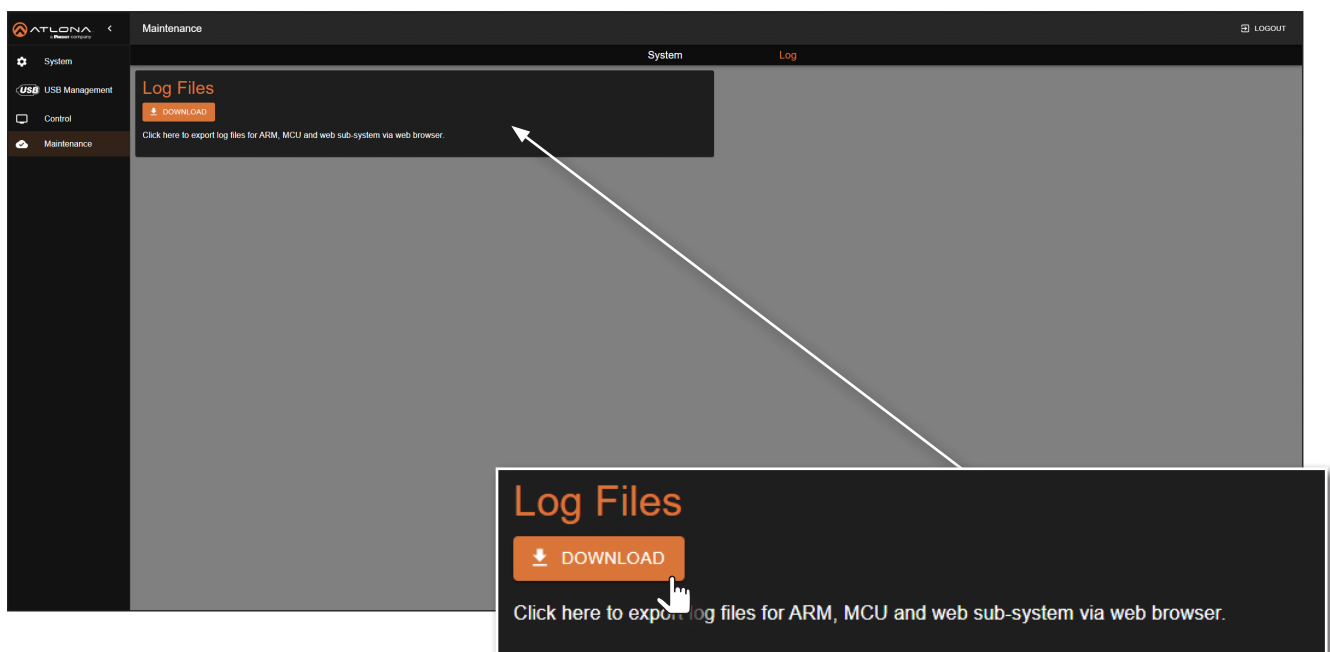

Configuration and Management Interfaces

Web Server

The AT-USB-EX350-WPH-KIT includes a built-in web server. Atlona recommends that the web server be used to set up the AT-USB-EX350-WPH-KIT, as it provides intuitive management of all features. Refer to [Logging in after Registration \(page 15\)](#) for more information.

The AT-USB-EX350-WPH-KIT is shipped with DHCP enabled. Once connected to a network, the DHCP server will automatically assign an IP address to the unit. Use an IP scanner to determine the IP address of the AT-USB-EX350-WPH-KIT. If a DHCP server cannot be located within 15 seconds, the AT-USB-EX350-WPH-KIT will be placed in [Automatic Private IP Addressing \(APIPA\) Mode \(page 11\)](#). If a static IP address is desired, refer to [Setting the IP Mode \(page 18\)](#).

Login

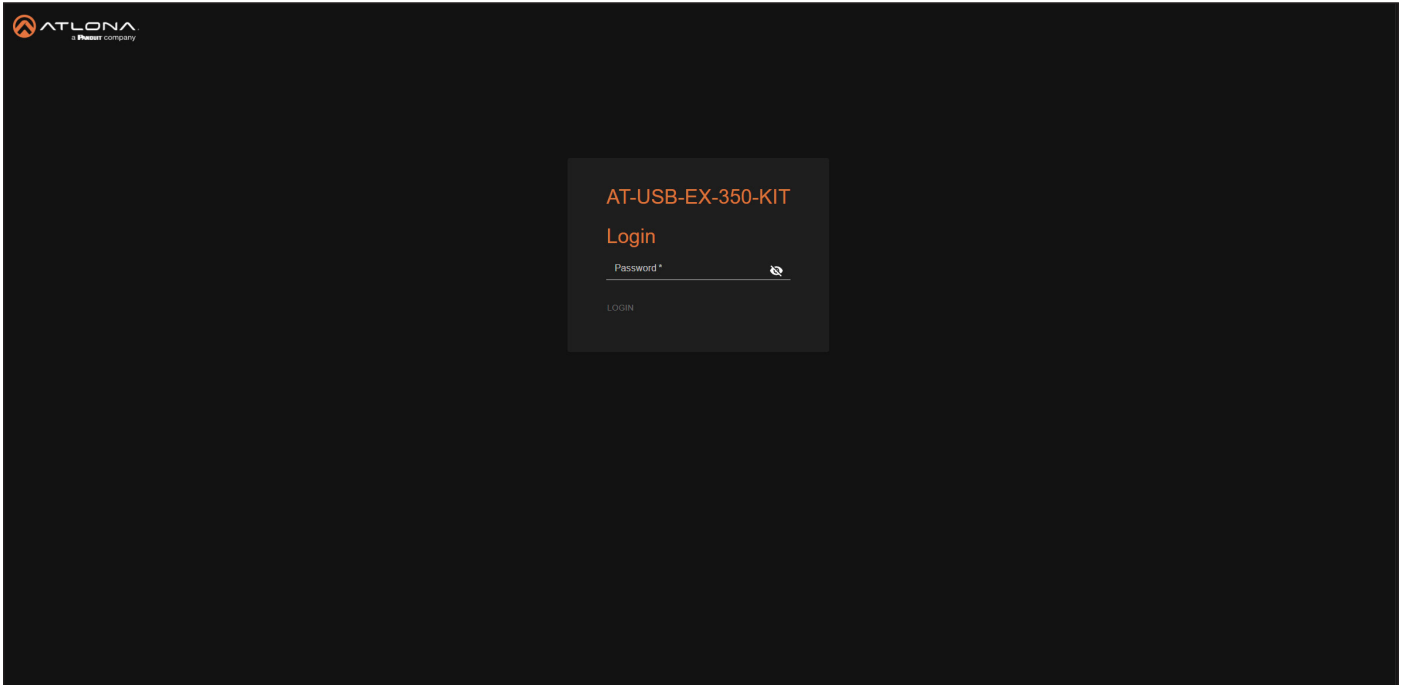

Password

Enter the password in this field. The password will be masked when entering it in this field. To toggle between password masking and unmasking, click the  icon.

LOGIN

Click this button to log in.

System > System

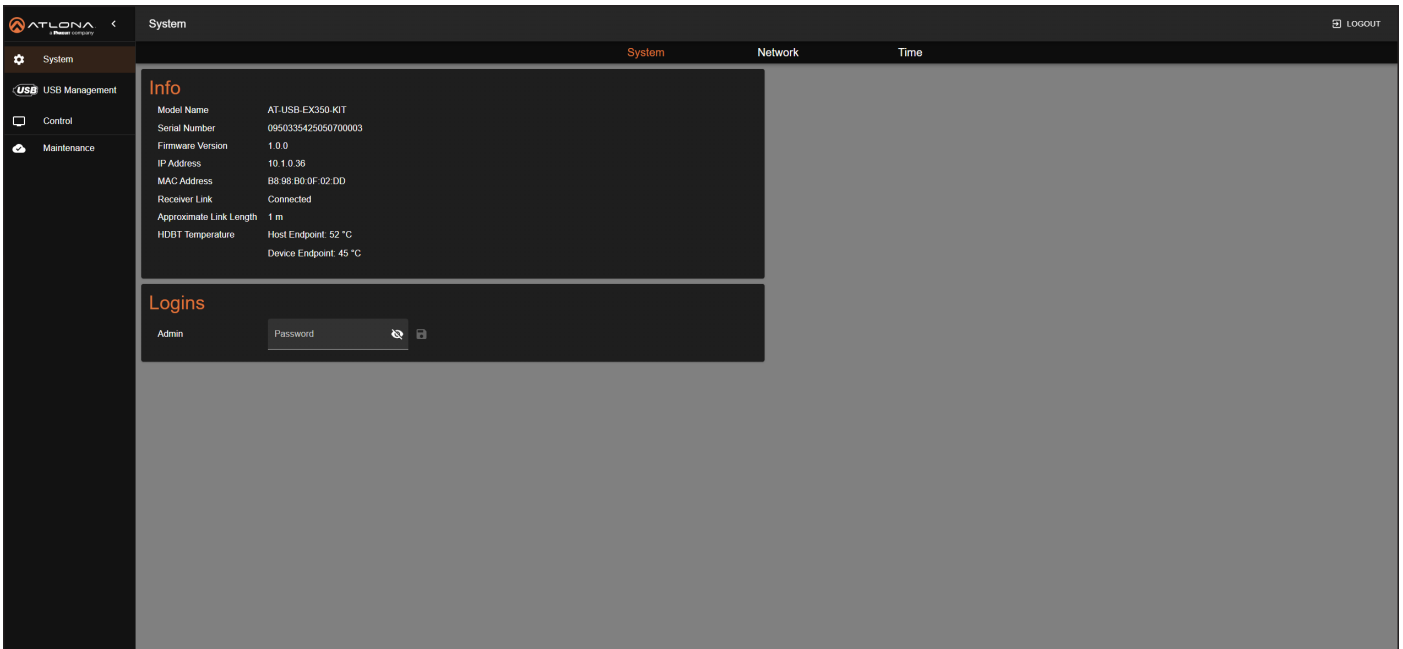

Info

Model Name

The model number of this product.

Serial Number

The serial number of the AT-USB-EX350-WPH-KIT.

Firmware Version

The version of firmware that the AT-USB-EX350-WPH-KIT is running. Always make sure to check the AT-USB-EX350-WPH-KIT product page, on the Atlona web site, for the latest version of firmware.

IP Address

The IP address of the AT-USB-EX350-WPH-KIT.

MAC Address

The MAC address of the AT-USB-EX350-WPH-KIT.

Logins

Admin

If changing the login password, enter it in this field. Refer to [Changing the Administrator Password \(page 17\)](#) for more information.

Receiver Link

Indicates the link status between the host endpoint and the device endpoint. If it says Disconnected, then check the cabling between the host endpoint and the device endpoint.

Approximate Link Length

Displays the estimated length of the category cable between the AT-USB-EX350-WPH-KIT host endpoint and the device endpoint.

HDBT Temperature

Displays the temperature, in Celsius, of the AT-USB-EX350-WPH-KIT host endpoint (HS) and device endpoint (DV).

Configuration and Management Interfaces

System > Network

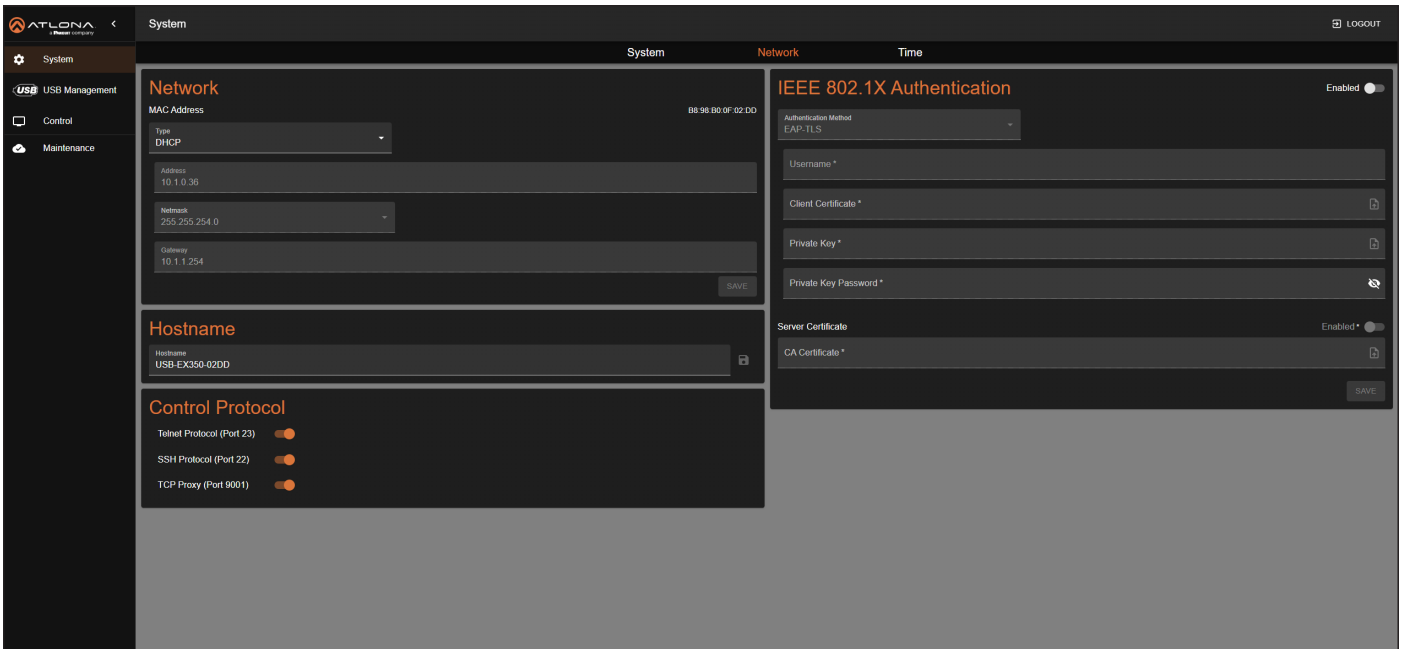

Network

MAC Address

The MAC address of the AT-USB-EX350-WPH-KIT.

Type

Click this drop-down list to select the IP mode of the AT-USB-EX350-WPH-KIT.

Setting	Description
DHCP	Uses an available DHCP server to assign an IP address.
Static	Allows the IP address, subnet mask, and gateway IP address to be entered manually.

IP

Enter the IP address of the AT-USB-EX350-WPH-KIT in this field. This field will only be available if **Type** is set to *Static*.

Netmask

Enter the subnet mask in this field. This field will only be available if **Type** is set to *Static*.

Gateway

Enter the gateway (router) address in this field. This field will only be available if **Type** is set to *Static*.

Hostname

Hostname

Enter the desired hostname in this field. Refer to [Setting the Host Name \(page 23\)](#) for more information.

Configuration and Management Interfaces

Control Protocol

Telnet Protocol (Port 23)

Click this toggle switch to enable or disable Telnet sessions. When enabled, the toggle switch will be orange. If disabled, then traffic on port 23 is forbidden.

SSH Protocol (Port 22)

Click this toggle switch to enable or disable SSH. When enabled, the toggle switch will be orange. If disabled, then traffic on port 22 is forbidden.

TCP Proxy (Port 9001)

Click this toggle switch to enable or disable TCP Proxy. When enabled, the toggle switch will be orange. If disabled, then traffic on port 22 is forbidden.

IEEE 802.1x Authentication

Refer to [IEEE 802.1x Authentication \(page 20\)](#) for more information.

Enabled

Click this toggle switch to enable or disable IEEE 802.1x authentication. When enabled, the toggle switch will be orange.

Authentication Method

Click this drop-down list to select the desired authentication method.

Protocol	Description
PEAP/MSCHAPv2	Protected EAP; uses basic credentials in addition to a CA (certificate authority) certificate.
EAP-TLS	EAP Transport Layer Security; uses a client certificate, private key, private key password, and CA (certificate authority) certificate.

The following fields are available, depending on the authentication method that is selected:

Username

The identifier for the user or device that is attempting to connect to the network.

Password

Enter the password in this field.

CA certificate

A digital certificate issued by a Certificate Authority (CA) that serves as the foundation of trust for verifying other certificates, such as client certificates and server certificates. To upload the certificate, click the **Enabled** button, above the **Server Certificate** field, then click the  icon to select the certificate.

Client Certificate

A digital certificate used to authenticate a device or user attempting to connect to the network. This is typically used in enterprise environments or when added security is desired. To upload the certificate, click the **Enabled** button, above the **Server Certificate** field, then click the  icon to select the certificate.

Private Key

A component of the public key infrastructure (PKI) and associated with the digital certificate. This key is securely stored and used to prove identity and enable secure communication. Click the  icon to select and upload the private key.

Private Key Password

This password is designed as a level of security used to protect the private key, associated with a digital certificate. The password is masked by default. Click the  icon to toggle masking.

SAVE

Click this button to commit changes.

Configuration and Management Interfaces

System > Time

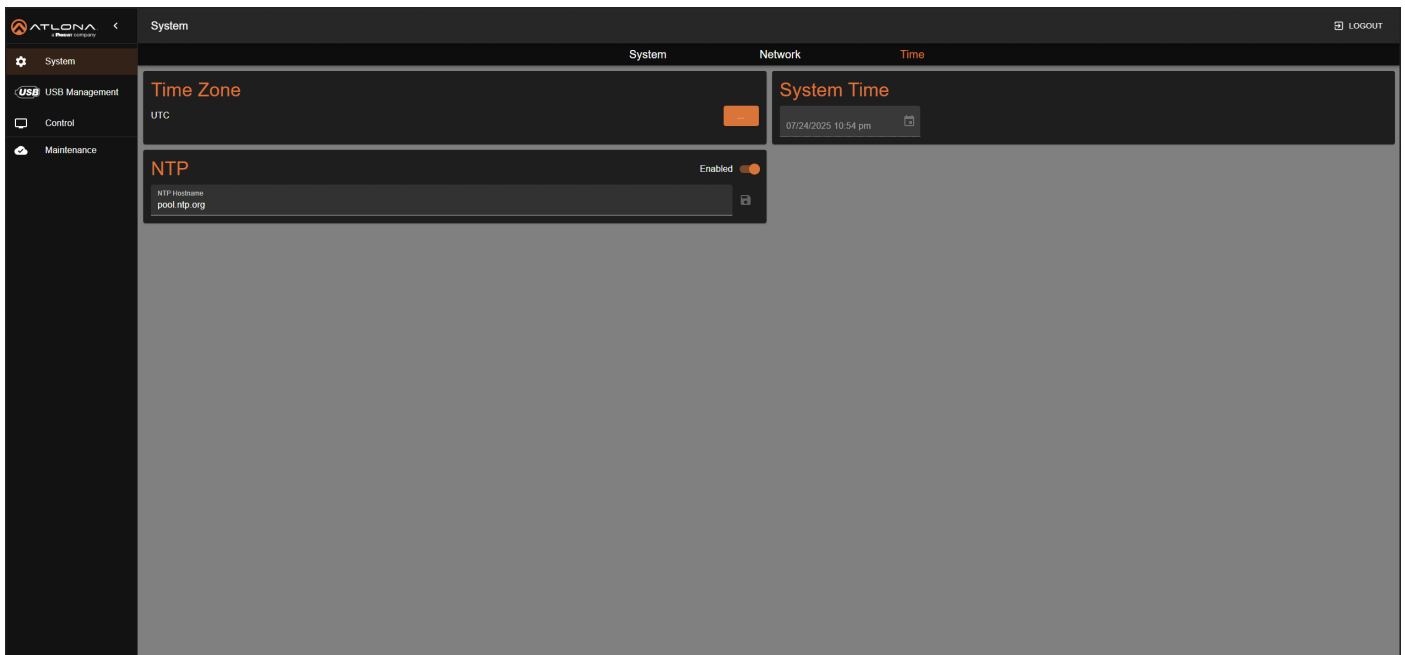

Time Zone

Click the  icon to set the time zone. Refer to [Setting the Time Zone \(page 24\)](#) for more information.

NTP

NTP Hostname

Enter the NTP server name in this field. The default server is `pool.ntp.org`.

System Time

Click the  icon to set the system time. Refer to [Setting the System Time \(page 26\)](#) for more information.

Configuration and Management Interfaces

USB Management > USB Configuration

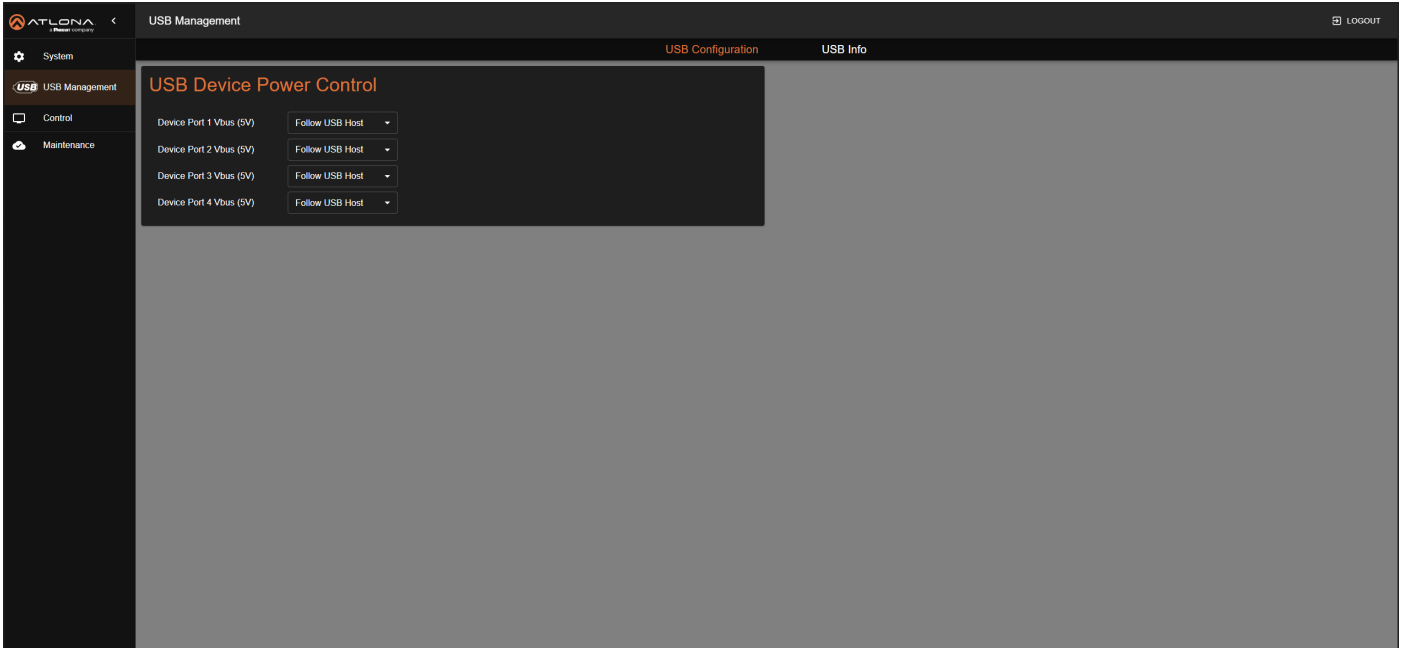

USB Device Power Control

Device Port [1...4] Vbus (5V)

Click the drop-down list to select the desired Vbus mode.

Setting	Description
Follow USB Host	Allows the USB hub port to toggle on and off based on the presence of a USB host connected to the host endpoint.
Always High	USB power is always enabled. For example, when connecting to a battery-powered speakerphone, selecting <i>Always High</i> ensures that the speakerphone continues to charge even when no USB host is connected. <div style="border: 1px solid black; padding: 10px; margin-top: 10px;">  <p>NOTE: Vbus will toggle high-low-high in this mode when a USB host is connected to the host endpoint to ensure proper enumeration of the USB device.</p> </div>
Always Low	USB power is disabled on the port.

Configuration and Management Interfaces

USB Management > USB Info

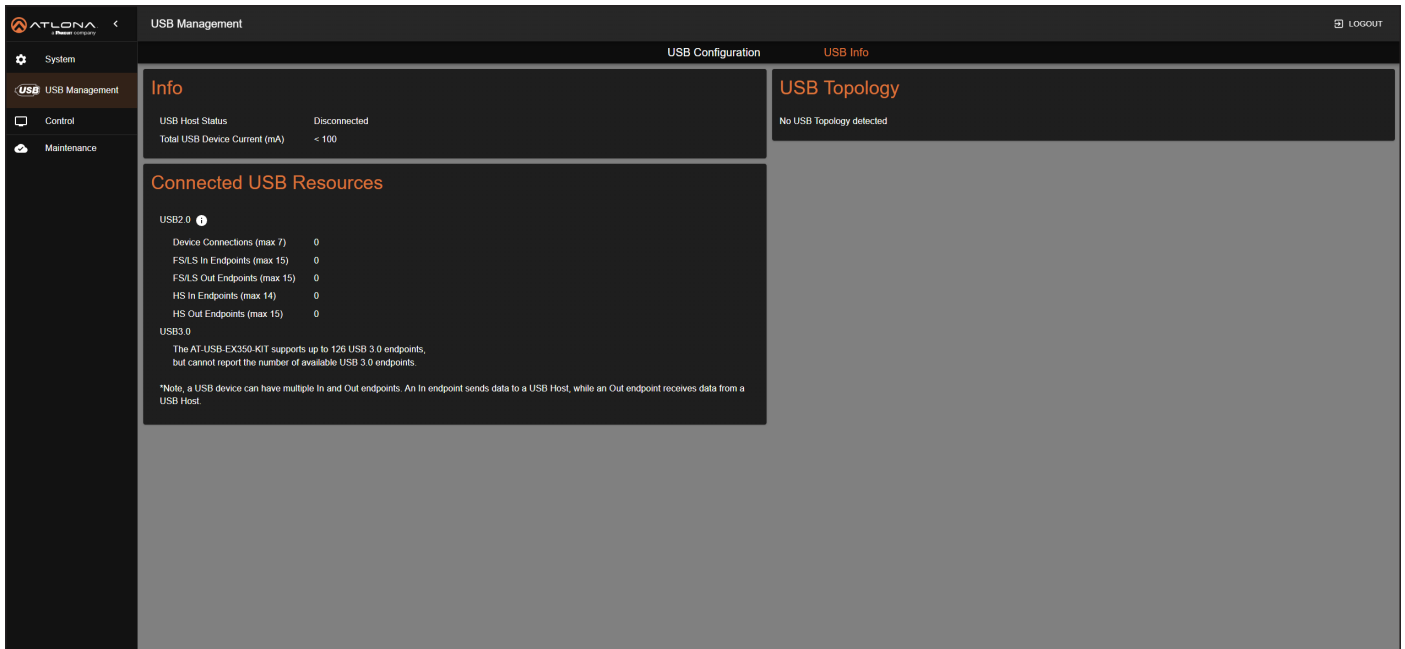

The screenshot displays the ATLONA USB Management interface. The left sidebar contains navigation options: System, USB Management (selected), Control, and Maintenance. The main content area is divided into two tabs: USB Configuration and USB Info (selected). The USB Info tab shows the following information:

- Info**
 - USB Host Status: Disconnected
 - Total USB Device Current (mA): < 100
- Connected USB Resources**
 - USB2.0**
 - Device Connections (max 7): 0
 - FS/LS In Endpoints (max 15): 0
 - FS/LS Out Endpoints (max 15): 0
 - HS In Endpoints (max 14): 0
 - HS Out Endpoints (max 15): 0
 - USB3.0**
 - The AT-USB-EX350-KIT supports up to 126 USB 3.0 endpoints, but cannot report the number of available USB 3.0 endpoints.
- USB Topology**
 - No USB Topology detected

*Note, a USB device can have multiple In and Out endpoints. An In endpoint sends data to a USB Host, while an Out endpoint receives data from a USB Host.

Info

Refer to [USB Info \(page 29\)](#) for more information.

USB Host Status

If the host device is connected to the **USB HOST (5G)** port on the AT-USB-EX350-WPH-KIT Host Endpoint, this field will display *Connected*.

USB Device Status

The **USB Device Port [1...4]** fields indicate whether a USB device is connected to the corresponding port. If a device is properly connected, the field will display *Connected*.

Total USB Device Current (mA)

Displays the total current in milliamperes consumed by the connected USB devices.

Configuration and Management Interfaces

Connected USB Resources

USB 2.0

The Valens chipset used in the AT-USB-EX350-WPH-KIT limits the number of USB 2.0 devices and endpoints that are supported by the link. This section provides information on connected USB 2.0 resources to help users understand the available resources based on already connected devices. Each USB device contains multiple input and output endpoints. The “In” endpoint transmits data to the USB host, while the “Out” endpoint receives data from the USB host.



DEFINITIONS

In Endpoint – Sends data to a USB host.

Out Endpoint – Receives data from a USB host.

LS – Low Speed (1.5 Mbps); used by keyboards / mouse devices.

FS – Fast Speed (12 Mbps); used by audio interfaces and older USB peripherals.

HS – High Speed (480 Mbps); used by hard drives and cameras.

- **Device Connections (max 7)**
Displays the number of USB 2.0 devices connected to the AT-USB-EX350-WPH-KIT. A maximum of seven USB devices are supported.
- **FS/LS In Endpoints (max 15)**
Displays the number of full-speed (FS) and low-speed (LS) “In” endpoints that are connected to the AT-USB-EX350-WPH-KIT. A maximum of 15 “In” endpoints are supported.
- **FS/LS Out Endpoints (max 15)**
Displays the number of full-speed (FS) and low-speed (LS) “Out” endpoints that are connected to the AT-USB-EX350-WPH-KIT. A maximum of 15 “Out” endpoints are supported.
- **HS In Endpoints (max 14)**
Displays the number of high-speed (HS) “In” endpoints that are connected to the AT-USB-EX350-WPH-KIT. A maximum of 14 “In” endpoints are supported.
- **HS Out Endpoints (max 15)**
Displays the number of high-speed (HS) “Out” endpoints that are connected to the AT-USB-EX350-WPH-KIT. A maximum of 15 “Out” endpoints are supported.

USB 3.0

The Valens chipset has a different USB implementation for USB 3.0 which does not impose any limitations beyond the USB standard. Due to the nature of this implementation, the AT-USB-EX350-WPH-KIT supports up to 126 USB 3.0 endpoints, but cannot report the number of available USB 3.0 endpoints.

Configuration and Management Interfaces

Additional Information on Devices and Hubs

When a host device is connected to the AT-USB-EX350-HS-WP and USB devices are connected to the AT-USB-EX350-DV, the **Connected USB Resources** and **USB Topology** windows display the relevant resource information. Devices connected directly to the AT-USB-EX350-DV will appear in these windows. If a hub is connected to a device port, only the hub's information is shown—the built-in web server cannot display details for devices connected through the hub. Refer to [USB Info \(page 29\)](#) for more information.

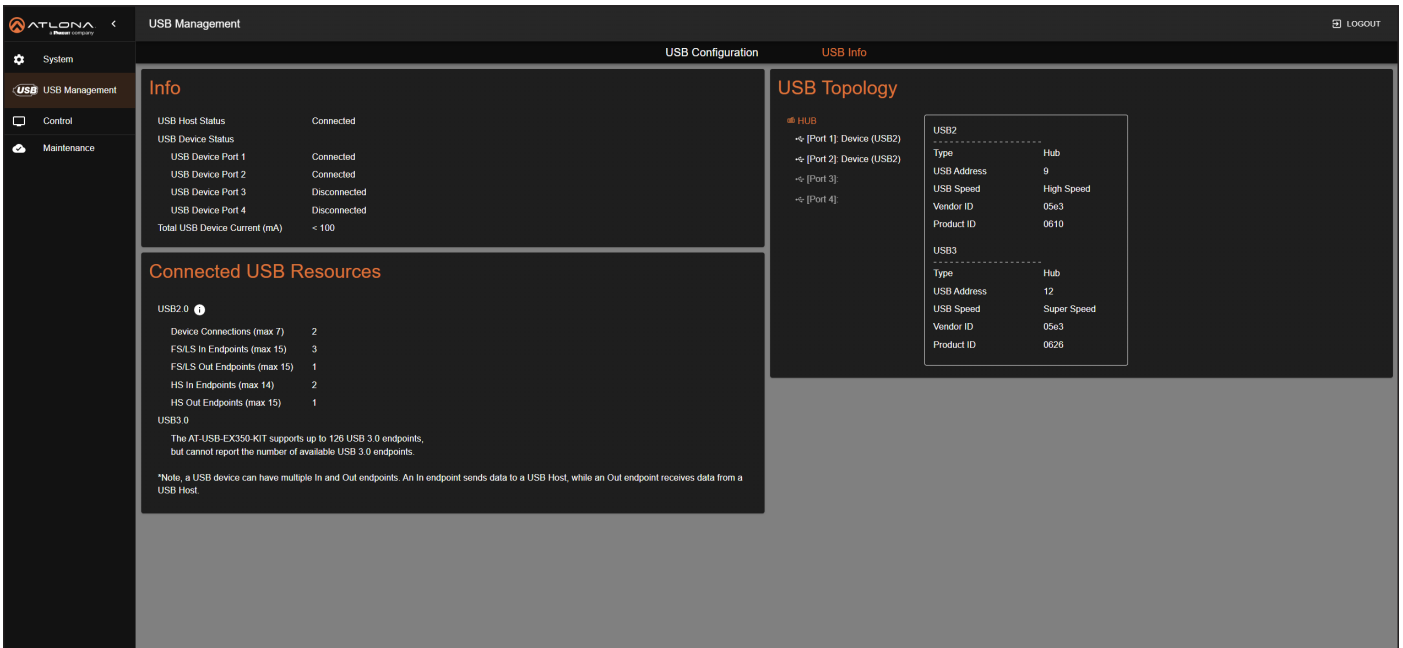

The screenshot displays the AT-USB-EX350 web management interface. The main content area is divided into several sections:

- Info:**
 - USB Host Status: Connected
 - USB Device Status:
 - USB Device Port 1: Connected
 - USB Device Port 2: Connected
 - USB Device Port 3: Disconnected
 - USB Device Port 4: Disconnected
 - Total USB Device Current (mA): < 100
- Connected USB Resources:**
 - USB2.0**
 - Device Connections (max 7): 2
 - FS/LS In Endpoints (max 15): 3
 - FS/LS Out Endpoints (max 15): 1
 - HS In Endpoints (max 14): 2
 - HS Out Endpoints (max 15): 1
 - USB3.0**
 - The AT-USB-EX350-KIT supports up to 128 USB 3.0 endpoints, but cannot report the number of available USB 3.0 endpoints.
- USB Topology:**
 - HUB**
 - [Port 1] Device (USB2)
 - Type: Hub
 - USB Address: 9
 - USB Speed: High Speed
 - Vendor ID: 05e3
 - Product ID: 0610
 - [Port 2] Device (USB2)
 - [Port 3]
 - [Port 4]
 - USB3**
 - Type: Hub
 - USB Address: 12
 - USB Speed: Super Speed
 - Vendor ID: 05e3
 - Product ID: 0626

Control

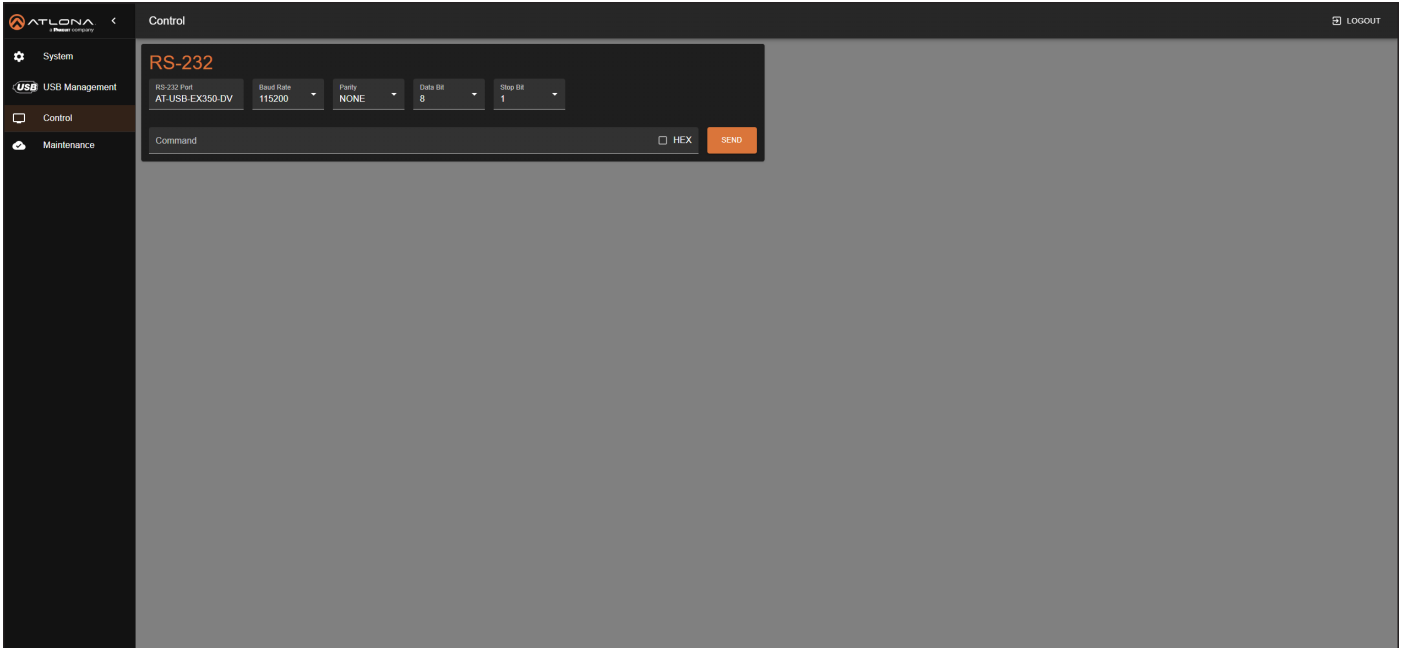

RS-232

RS-232 Port

The name of the endpoint that includes the **RS-232** port. This field cannot be changed.

Baud Rate

Click this drop-down list to select the data transmission rate in bit-per-second (bps). Available options are 9600, 19200, 38400, 57600, or 115200.

Parity

Click this drop-down list to select the parity bit value. The parity bit helps detect single-bit errors in data transmission. The parity bit cannot correct errors. However, if an error does occur, the receiver can then request that the data be retransmitted.

Setting	Description
NONE	No parity (error checking) is applied.
ODD	The parity bit is set so that the total number of 1 bits in the data, including the parity bit, is <i>odd</i> . For example, 10110011 contains five 1 bits, which is an odd value. Applying ODD parity, the parity bit is set to 0 and the data becomes 101100110, maintaining an odd number of 1 bits in the data.
EVEN	The parity bit is set so that the total number of 1 bits in the data, including the parity bit, is <i>even</i> . For example, 10110011 contains five 1 bits, which is an odd value. Applying EVEN parity, the parity bit is set to 1 and the data becomes 101100111, maintaining an even value of 1 bits in the data.

Data Bits

Click this drop-down list to select the number of data bits in each packet. Typically, packets are sent in bytes (8 bits). However, some older systems may use 7-bit data. Available options are 7 or 8.

Stop Bits

Click this drop-down list to select the number of stop bits. Stop bits are used to signal the end of a data frame. A value of 1 is standard. Available options are 1 or 2.

Configuration and Management Interfaces

Command

Enter the command in the **Command** field. The command can be in either ASCII or hexadecimal format. If the command is entered in hexadecimal format, click the **HEX** checkbox.

SEND

Click the **SEND** button to verify that the command works properly.

Maintenance > System

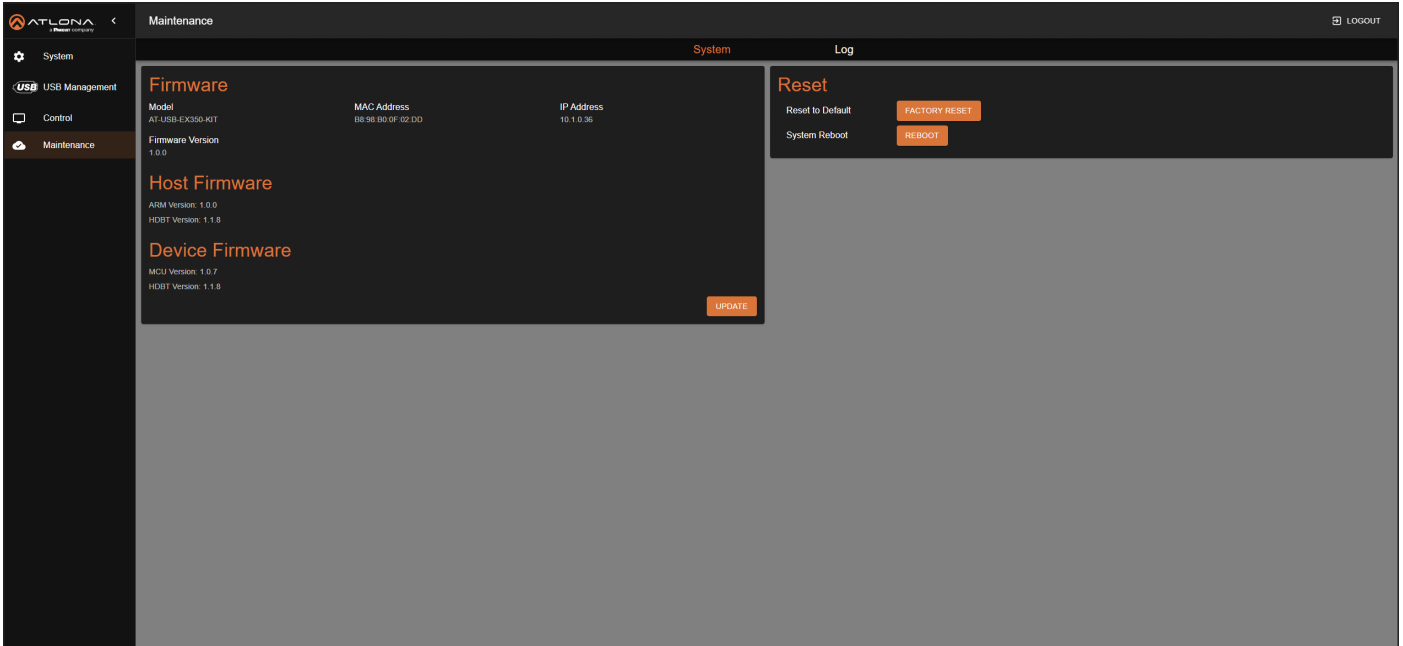

Firmware

Model

The model of this product.

Firmware Version

The version of firmware that the AT-USB-EX350-WPH-KIT is running. Always make sure to check the AT-USB-EX350-WPH-KIT product page, on the Atlona web site, for the latest version of firmware.

MAC Address

The MAC address of the AT-USB-EX350-WPH-KIT.

IP Address

The IP address of the AT-USB-EX350-WPH-KIT.

Host Firmware

ARM Version

The version of firmware used by the ARM processor.

HDBT Version

The version of HDBaseT[®] firmware.

Device Firmware

MCU Version

The version of firmware used by the microcontroller in the device endpoint.

HDBT Version

The version of HDBaseT[®] firmware.

Reset

Reset to Default

Click the FACTORY RESET button to reset the AT-USB-EX350-WPH-KIT to factory-default settings.

System Reboot

Click the REBOOT button to reboot the AT-USB-EX350-WPH-KIT. All settings will be preserved.

Maintenance > Log

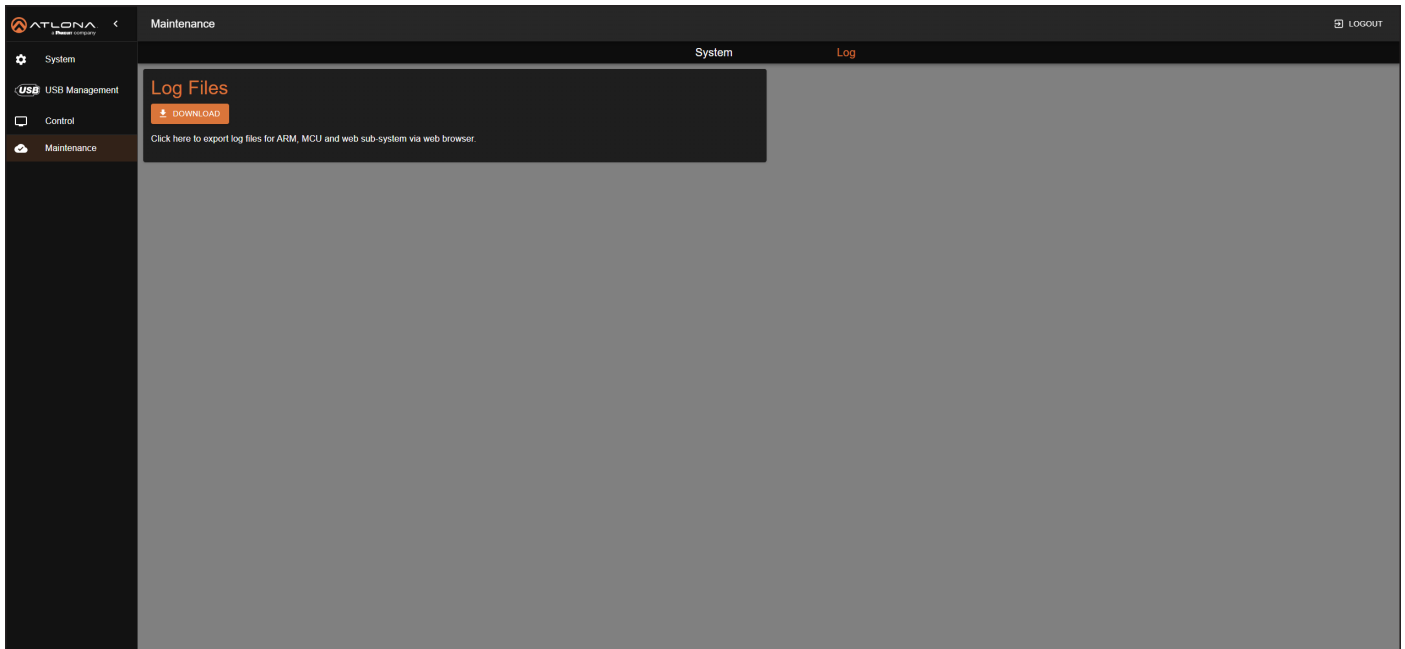

Log Files

DOWNLOAD

Click this button to download log files to the `C:\Users\[Username]\Downloads` folder on the PC. Log files are used for troubleshooting purposes and may be requested by Atlona Technical Support Engineers.

Appendix

Host Device Mounting Instructions

The AT-USB-EX350-WPH-KIT includes mounting brackets, which can be used to attach the units to any flat surface. Use the included screws to attach the mounting brackets.

1. Locate the included screws in the packaging.
2. Align the mounting bracket with the enclosure, matching the holes on the side of the enclosure with those on the bracket, as shown below.

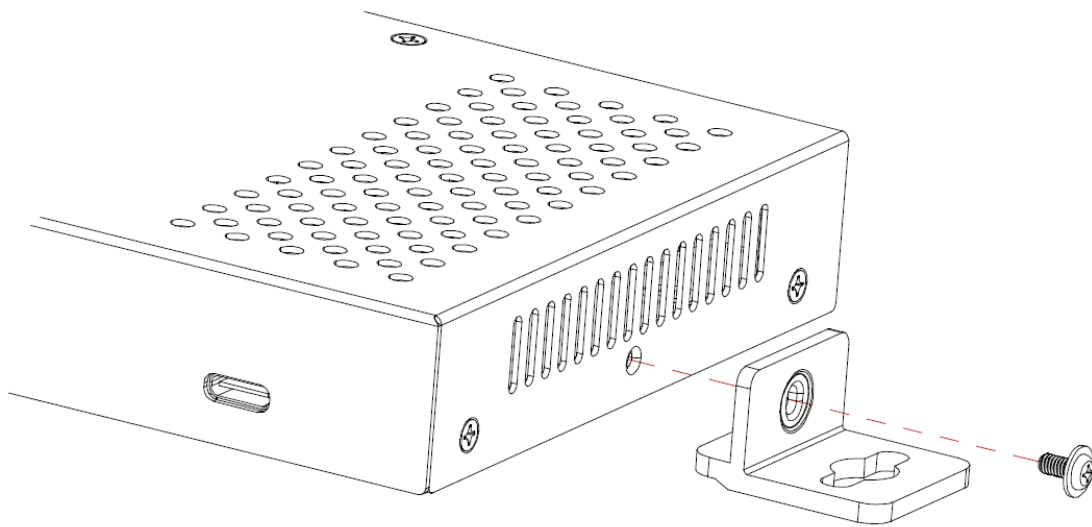

3. Secure the bracket using a small Phillips screwdriver and a screw.
4. Repeat steps 2 and 3 for the other mounting bracket.
 - If using a drywall surface, a #6 drywall screw is recommended.
5. Attach the unit to a flat surface using the oval-shaped holes on each bracket.

Updating the Firmware

Updating the firmware can be performed using the built-in web server or over USB.

Updating using the Web Server

Requirements:

- AT-USB-EX350-WPH-KIT
- Firmware file
- Computer on the same network as the AT-USB-EX350-WPH-KIT

1. Download the firmware file from the **Firmware** tab on the Atlona AT-USB-EX350-WPH-KIT product page. Then, extract the contents of the .zip file to a folder on your computer's desktop.
2. Power on the unit and connect an Ethernet cable from the computer, containing the firmware, to the same network where the AT-USB-EX350-WPH-KIT connected.
3. Login to the web server.
4. Click **Maintenance** in the side menu bar.
5. Click **System** in the top menu bar.

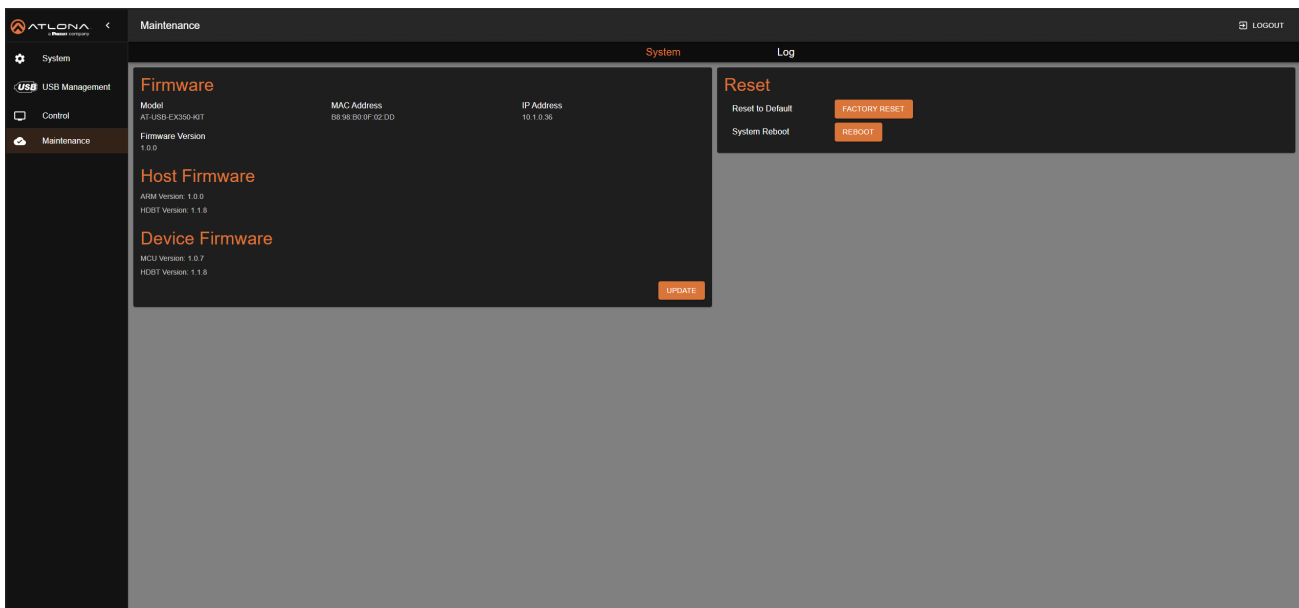

6. The firmware version information for both the host (AT-USB-EX350-HS-WP) and the device (AT-USB-EX350-DV) endpoints will be displayed.
7. Click the **UPDATE** button.
8. The Open dialog will be displayed. Locate the firmware file and click the Open button

9. After the firmware is uploaded to the AT-USB-EX350-WPH-KIT, the following screen will be displayed. Note that other screens will be displayed during the firmware update process.



IMPORTANT: The firmware update process may take several minutes. Do not disconnect power from the AT-USB-EX350-WPH-KIT during the update process.

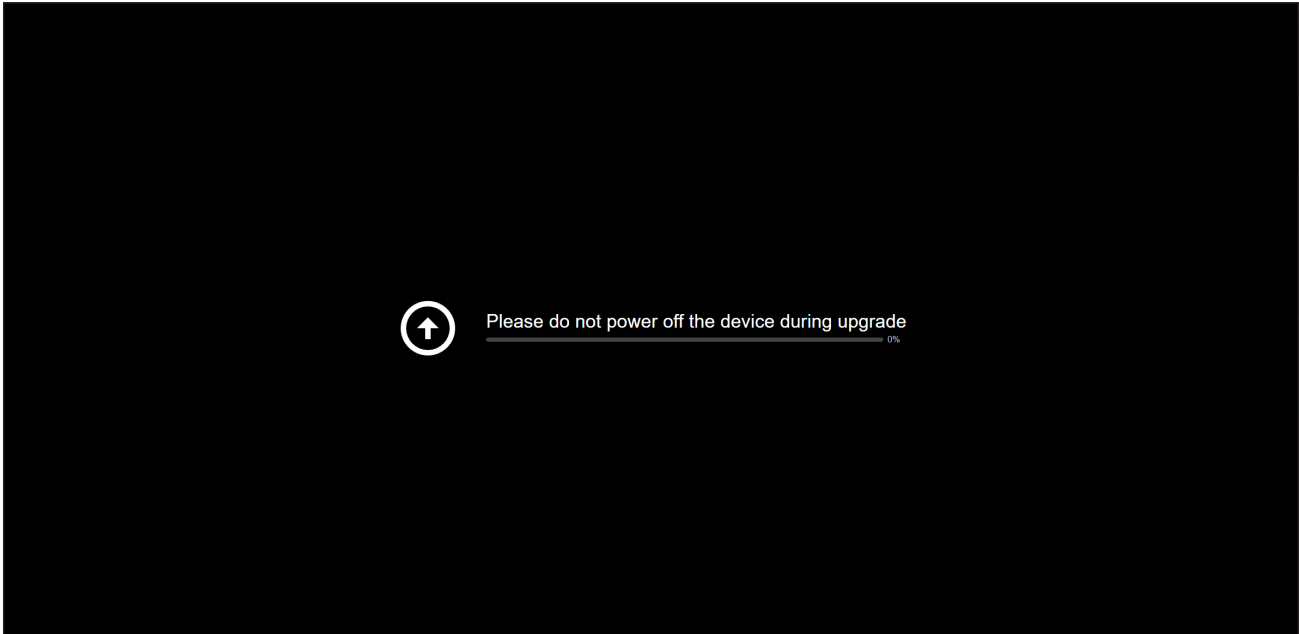

10. Once the update process is complete, the AT-USB-EX350-WPH-KIT will automatically reboot and the **Login** screen will be displayed.

Updating over USB

Requirements:

- AT-USB-EX350-WPH-KIT
- USB-C cable
- Firmware file

1. Download the firmware file from the **Firmware** tab on the AT-USB-EX350-WPH-KIT product page. Then, extract the contents of the .zip file to a folder on your computer's desktop.
2. Power on the AT-USB-EX350-WPH-KIT.
3. Connect a USB-C cable from the **MGMT** port on the AT-USB-EX350-WPH-KIT (Host Endpoint) to the computer with the firmware file.
4. Press and hold the **IP MODE** button on the front panel of the Host Endpoint for approximately 3 seconds, then release.
5. The "USB UPDATE" folder will be displayed on the PC. If the folder does not open automatically, locate and open it through Windows Explorer.
6. Drag and drop the firmware file to the drive, then disconnect the USB cable from the PC.
7. Wait 15 seconds. The **PWR** LED will begin to flash when the update process begins.



IMPORTANT: The firmware update process may take a few minutes. Do not disconnect power from the AT-USB-EX350-WPH-KIT during the update process.

8. Once the firmware update has completed, the AT-USB-EX350-WPH-KIT will automatically reboot. The **PWR** LED will be off during this time.
9. Once the **PWR** LED returns to solid green, verify that the firmware version has been updated.

Specifications

USB Capabilities	
Protocol Support	USB 2.0, USB 3.2 Gen 1 (5 Gbps)
USB 2.0 Capabilities ⁽¹⁾	Maximum hubs: 9 Maximum hub tiers: 5 Maximum devices: 7 Maximum endpoints: 14 (IN), 15 (OUT)
USB 3.2 Gen 1 Capabilities ⁽¹⁾	Maximum hub tiers: 5 Maximum end points: 126
USB Transfer Types	Control, Bulk, Interrupt, Isochronous
Internal Hubs	USB 2.0: 1 Hub, 1 Tier USB 3.2 Gen 1: 2 Hubs, 2 Tiers
USB Power	Host: No Power Device: max 1.5A per port, 3.2A total across all device ports
USB Device VBUS Control	Per-port settings: Follow USB Host, Always High, Always Low
Bandwidth ⁽²⁾	USB 2.0: 480 Mbps USB 3.2 Gen 1: 5 Gbps

Ethernet	
Port	1 x RJ45 on Host Endpoint
Standards and Protocols	HTTP, HTTPS, Telnet, SSH, JSON over WebSockets, TCP Proxy for RS-232, NTP
Speeds	10/100 Mbps
Addressing	DHCP, Static – selectable through built-in web server and API commands
802.1x Support	PEAP-MSCHAPv2, EAP-TLS

RS-232	
Port	1 x 3-pin captive screw on Device Endpoint
Use	External device control via TCP Proxy
Baud Rates	9600, 19200, 38400, 57600, 115200
Data Flow	Bidirectional

Distance	Feet	Meters
CAT 6a U/FTP - straight run	330	100
CAT 6a U/FTP - through patch panel/coupler	295	90
CAT 6a UTP - either straight run or through patch panel/coupler	230	70
CAT 5e UTP - either straight run or through patch panel/coupler	164	50

Indicators	
Host Endpoint	
PWR	1 x LED, green
LINK	1 x LED, green
LAN	1 x LED, green; 1 x LED, amber
HDBT-USB3	1 x LED, green (LINK); 1 x LED, amber (FW)
Device Endpoint	
PWR	1 x LED, green
HDBT-USB3	1 x LED, green (LINK); 1 x LED, amber (FW)

Connectors (Host Endpoint)				
USB HOST (5G)	1 x USB-C, locking			
LAN	1 x RJ45			
HDBT-USB3	1 x RJ45			
48V / 1.36A	1 x 2-pin captive screw			
Connectors (Device Endpoint)				
USB DEVICES (5G)	3 x USB-A 1 x USB-C, locking			
DEBUG	1 x USB-C			
RS-232	1 x 3-pin captive screw			
HDBT-USB3	1 x RJ45			
48V / 1.36A	1 x 2-pin captive screw			
Environmental		Fahrenheit	Celsius	
Operating Temperature		+32 to +104	0 to +40	
Storage Temperature		-4 to +158	-20 to +70	
Operating Humidity (RH)		20% to 90%, non-condensing		
Power	Powered from	Total System Power	Host Endpoint	Device Endpoint
Consumption (under full USB device load)	Host Endpoint	33 W (max.)	25.4 BTU/h	21 BTU/h
	Device Endpoint	29 W (max.)	11.1 BTU/h	25 BTU/h
External Power Supply	Input: 100 - 240 V AC, 50/60 Hz Output: 48 V DC / 1.36 A			
Dimensions (H x W x D)		Inches	Millimeters	
Host Endpoint		4.17 x 1.77 x 2.24	106 x 45 x 57	
Device Endpoint		0.91 x 5.31 x 3.94	23 x 135 x 100	
Weight	Pounds		Kilograms	
Host Endpoint	0.51		0.23	
Device Endpoint	0.71		0.32	
Certification				
Extender Kit	CE, FCC, UKCA, RCM			
Power Supply	CE, FCC, UKCA, RCM, UL			
Compliance				
NDAA-889	Yes			
Warranty				
Device	To view the product warranty, use the following link: https://atlon.com/warranty			

(1) A USB device can have multiple In and Out endpoints. An In endpoint sends data to a USB Host, while an Out endpoint receives data from a USB Host.

(2) Specified bandwidth is the total available bandwidth. Actual bandwidth available for payload data will be reduced by USB and transport overhead. Practical payload data rates will be approximately 320 Mbps for USB 2.0 and 3.8 Gbps for USB 3.0.

